



# Judo Grand-Prix Budapest 2015

(HUN Budapest, 13-14 June 2015)

			-48	-52	-57	-63	-70	-78	+78		-60	-66	-73	-81	-90	-100	+100		
1.		ALB Albania							0		1							1	1
2.		ANG Angola					1		1				1					1	2
3.		ARG Argentina	1						1									0	1
4.		AUS Australia				1			1				1		1			2	3
5.		AUT Austria				1			1		1		2		1			4	5
6.		AZE Azerbaijan							0		1							1	1
7.		BAH Bahamas			1				1									0	1
8.		BEL Belgium		1					1		1	1			1			3	4
9.		BIH Bosnia-Herzegovina							1	1								0	1
10.		BLR Belarus							2	2	1							1	3
11.		BUL Bulgaria			1				1	1	1			1				2	3
12.		CAN Canada							0			1	2					3	3
13.		CHN China							0		1	2	2	1	1	1		8	8
14.		CMR Cameroon				1			1									0	1
15.		CRO Croatia				1		1	1	3						1		1	4
16.		CUB Cuba	1	1		1	1	2	1	7			1	1	1	1		4	11
17.		CZE Czech Republic							0		1		1	1			1	4	4
18.		DEN Denmark							0							1		1	1
19.		DOM Dominican Republic	1	1	1				1	4		1	1	2	2			6	10
20.		EGY Egypt							0			1		2		1		4	4
21.		ESP Spain		1	2	1	1	2	7		1	1	2	2	1	1	1	9	16
22.		EST Estonia							0					1	1	1	1	4	4
23.		FIN Finland							0		1	1	1	1	2			6	6
24.		FRA France							0			1		2	1			4	4
25.		GBR Great Britain	1	1	1			2	1	6	1	2	2	2	2	1		10	16
26.		GBS Guinea-Bissau	1						1									0	1
27.		GEO Georgia					1		1		1	1				2		4	5
28.		GER Germany	1	2	2	2	2	2	2	13		1	2	2	2	1	2	10	23
29.		GHA Ghana				1			1				1					1	2
30.		GRE Grece							0				1	2				3	3
31.		HUN Hungary	2	4	3	3	4	2	18		3	4	4	4	4	2	4	25	43
32.		ISL Iceland							0					1			1	2	2
33.		ISR Israel	1	2	1				4			1		1	1		1	4	8
34.		ITA Italy		1	2		1	1	5			1						1	6
35.		JPN Japan	1		1	1	1	1	5		1						1	2	7
36.		KAZ Kazakhstan	1			1		1	2	5	2	2	2	1	2	1	1	11	16
37.		KGZ Kyrgyzstan							0		1			1				2	2
38.		KSA Saudi Arabia							0		1	1	1	1			1	5	5
39.		KUW Kuwait							0								1	1	1



# Judo Grand-Prix Budapest 2015

(HUN Budapest, 13-14 June 2015)

			-48	-52	-57	-63	-70	-78	+78		-60	-66	-73	-81	-90	-100	+100		
40.		LAT Latvia							0					1	1	1	1	4	4
41.		LTU Lithuania							0					1		1		2	2
42.		LUX Luxembourg		1	1		1		3									0	3
43.		MAR Morocco				1	1		2	1	1				1		1	4	6
44.		MDA Moldova	2						2	1		1	2					4	6
45.		MNE Montenegro			1				1			2	1			1		4	5
46.		MOZ Mozambique							0	1	2	1						4	4
47.		NED Netherlands					1	1	2				1	1				2	4
48.		NOR Norway							0				1					1	1
49.		POL Poland		1			1		2									0	2
50.		POR Portugal		1		1		1	3	1	2	2	2	2	1	1		9	12
51.		PUR Puerto Rico							0				1	1				2	2
52.		ROU Romania	1						1		1		1			1		3	4
53.		RUS Russia	2		1	2	2	2	9	1	2	2	2	2	1	2	2	12	21
54.		SEN Senegal			1				1							1		1	2
55.		SLO Slovenia		1	1	1		1	4		2	1	2	1	1	1	1	8	12
56.		SRB Serbia	1						2		2		1			1		4	6
57.		SVK Slovakia				1			1				1	1				2	3
58.		SWE Sweden				2			2				1	1	2	1		5	7
59.		TJK Tajikistan							0							1	1	2	2
60.		TPE Chinese Taipei			1				1	1								1	2
61.		TUN Tunisia		1			1	1	3								1	1	4
62.		TUR Turkey	1			1		2	4	1	1	1			1	1		5	9
63.		UAE United Arab Emirates							0						1	1		2	2
64.		UKR Ukraine							0				1	1	2	2	2	8	8
65.		USA United States of America		1	2	2	1	1	7	1	1	1			1	1		5	12
66.		UZB Uzbekistan							0	2	2	2	2	2	2	1	1	12	12
67.		VEN Venezuela	1	1	1	1	1	1	7	1	1				1	1	1	5	12
			19	21	24	26	21	21	16	148	28	41	44	51	38	34	26	262	410



# Judo Grand-Prix Budapest 2015

(HUN Budapest, 13-14 June 2015)

<b>-60 kg</b>		
1.	SMETOV, Yeldos	KAZ
2.	IMASHEV, Aibek	KAZ
3.	LUTFILLAEV, Sharafuddin	UZB
3.	SHISHIME, Toru	JPN
5.	GARRIGOS, Francisco	ESP
5.	TSAI, Ming Yen	TPE
7.	CHKHVIMIANI, Lukhumi	GEO
7.	PETRIKOV, Pavel	CZE

<b>-66 kg</b>		
1.	SMAGULOV, Zhansay	KAZ
2.	SEIDL, Sebastian	GER
3.	GALSTYAN, Arsen	RUS
3.	OLEINIC, Sergiu	POR
5.	LAROSE, David	FRA
5.	SOBIROV, Rishod	UZB
7.	MA, Duanbin	CHN
7.	MUKANOV, Azamat	KAZ

<b>-73 kg</b>		
1.	UNGVARI, Miklos	HUN
2.	DRAKSIC, Rok	SLO
3.	DELPOPOLO, Nicholas	USA
3.	VAN TICHEL, Dirk	BEL
5.	MACIAS, Tommy	SWE
5.	WANDTKE, Igor	GER
7.	ESTRADA, Magdiel	CUB
7.	JEZEK, Jaromir	CZE

<b>-81 kg</b>		
1.	IMAMOV, Yakhyo	UZB
2.	SCHMITT, Alain	FRA
3.	MARESCH, Sven	GER
3.	MOUSTOPOULOS, Roman	GRE
5.	SEMENOV, Stanislav	RUS
5.	WIECZERZAK, Alexander	GER
7.	KERMARREC, Julian	FRA
7.	SOBIROV, Shaxzod	UZB

<b>-90 kg</b>		
1.	DIAS, Celio	POR
2.	BUFFET, Romain	FRA
3.	GONZALEZ, Asley	CUB
3.	KOCHMAN, Li	ISR
5.	ODENTHAL, Marc	GER
5.	RANDL, Milan	SVK
7.	BOZBAYEV, Islam	KAZ
7.	NHABALI, Quedjau	UKR

<b>-100 kg</b>		
1.	DARWISH, Ramadan	EGY
2.	PETERS, Dimitri	GER
3.	BISULTANOV, Adlan	RUS
3.	BLOSHENKO, Artem	UKR
5.	KUMRIC, Zlatko	CRO
5.	PACEK, Martin	SWE
7.	CHERKASOV, Mykhailo	UKR
7.	SAYIDOV, Ramziddin	UZB

<b>+100 kg</b>		
1.	OJITANI, Takeshi	JPN
2.	GORDIENKO, Oleksandr	UKR
3.	HEINLE, Sven	GER
3.	JABALLAH, Faicel	TUN
5.	BOR, Barna	HUN
5.	VOLKOV, Andrey	RUS
7.	BREITBARTH, Andre	GER
7.	CERAJ, Matjaz	SLO



# Judo Grand-Prix Budapest 2015

(HUN Budapest, 13-14 June 2015)

<b>-48 kg</b>		
1.	PARETO, Paula	ARG
2.	TONAKI, Funa	JPN
3.	KONDRATYEVA, Nataliya	RUS
3.	LIMA, Taciana	GBS
5.	LOKMANHEKIM, Dilara	TUR
5.	MESTRE ALVAREZ, Dayaris	CUB
7.	MATEI, Ioana	ROU
7.	PODRYADOVA, Alexandra	KAZ

<b>-52 kg</b>		
1.	KRAEH, Mareen	GER
2.	ERTL, Maria	GER
3.	GOMEZ, Laura	ESP
3.	RAMOS, Joana	POR
5.	COHEN, Gili	ISR
5.	MORETTI, Elena	ITA
7.	DELGADO, Angelica	USA
7.	PIENKOWSKA, Karolina	POL

<b>-57 kg</b>		
1.	LIEN, Chen-Ling	TPE
2.	WAECHTER, Viola	GER
3.	MALLOY, Marti	USA
3.	TAMAOKI, Momo	JPN
5.	KARAKAS, Hedvig	HUN
5.	MINAKAWA, Camila	ISR
7.	DIEDHIOU, Hortance	SEN
7.	ROPER, Miryam	GER

<b>-63 kg</b>		
1.	TRSTENJAK, Tina	SLO
2.	SURAKATOVA, Pari	RUS
3.	BERNHOLM, Anna	SWE
3.	HERMANSSON, Mia	SWE
5.	LABAZINA, Marta	RUS
5.	ZOUAK, Rizlen	MAR
7.	HAECKER, Katharina	AUS
7.	SZABO, Franciska	HUN

<b>-70 kg</b>		
1.	BERNABEU, Maria	ESP
2.	DIEDRICH, Szaundra	GER
3.	BREITENBACH, Anett	HUN
3.	VARGAS KOCH, Laura	GER
5.	NIANG, Assmaa	MAR
5.	STAM, Esther	GEO
7.	CORTES ALDAMA, Onix	CUB
7.	GERCSAK, Szabina	HUN

<b>-78 kg</b>		
1.	HARRISON, Kayla	USA
2.	VELENSEK, Anamari	SLO
3.	MALZAHN, Luise	GER
3.	VERKERK, Marhinde	NED
5.	GALEONE, Assunta	ITA
5.	UMEKI, Mami	JPN
7.	JOO, Abigel	HUN
7.	POWELL, Natalie	GBR

<b>+78 kg</b>		
1.	SAYIT, Kayra	TUR
2.	CHEIKH ROUHO, Nihel	TUN
3.	KONITZ, Franziska	GER
3.	ORTIZ, Idalys	CUB
5.	ISSANOVA, Gulzhan	KAZ
5.	SLUTSKAYA, Maryna	BLR
7.	CERIC, Larisa	BIH
7.	KAYA, Belkis Zehra	TUR



# Judo Grand-Prix Budapest 2015: Medals

(HUN Budapest, 13-14 June 2015)

				1st place	2nd place	3rd place	5th place	7th place
1.		KAZ	Kazakhstan	2	1	0	1	3
2.		GER	Germany	1	5	5	3	2
3.		SLO	Slovenia	1	2	0	0	1
4.		JPN	Japan	1	1	2	1	0
5.		USA	United States of America	1	0	2	0	1
6.		POR	Portugal	1	0	2	0	0
7.		HUN	Hungary	1	0	1	2	3
8.		UZB	Uzbekistan	1	0	1	1	2
9.		ESP	Spain	1	0	1	1	0
10.		TUR	Turkey	1	0	0	1	1
11.		TPE	Chinese Taipei	1	0	0	1	0
12.		ARG	Argentina	1	0	0	0	0
12.		EGY	Egypt	1	0	0	0	0
14.		FRA	France	0	2	0	1	1
15.		RUS	Russia	0	1	3	3	0
16.		UKR	Ukraine	0	1	1	0	2
17.		TUN	Tunisia	0	1	1	0	0
18.		SWE	Sweden	0	0	2	2	0
19.		CUB	Cuba	0	0	2	1	2
20.		ISR	Israel	0	0	1	2	0
21.		BEL	Belgium	0	0	1	0	0
21.		GBS	Guinea-Bissau	0	0	1	0	0
21.		GRE	Greece	0	0	1	0	0
21.		NED	Netherlands	0	0	1	0	0
25.		ITA	Italy	0	0	0	2	0
25.		MAR	Morocco	0	0	0	2	0
27.		GEO	Georgia	0	0	0	1	1
28.		BLR	Belarus	0	0	0	1	0
28.		CRO	Croatia	0	0	0	1	0
28.		SVK	Slovakia	0	0	0	1	0
31.		CZE	Czech Republic	0	0	0	0	2
32.		AUS	Australia	0	0	0	0	1
32.		BIH	Bosnia-Herzegovina	0	0	0	0	1
32.		CHN	China	0	0	0	0	1
32.		GBR	Great Britain	0	0	0	0	1
32.		POL	Poland	0	0	0	0	1
32.		ROU	Romania	0	0	0	0	1
32.		SEN	Senegal	0	0	0	0	1



# Judo Grand-Prix Budapest 2015: Medals

(HUN Budapest, 13-14 June 2015)

1st place	2nd place	3rd place	5th place	7th place
-----------	-----------	-----------	-----------	-----------



# Judo Grand-Prix Budapest 2015

(HUN Budapest, 13-14 June 2015)

# -60 kg

29 Judoka

Pool A

	LUTFILLAEV, Sharafuddin	UZB	1	LUTFILLAEV, Sharafuddin	17	LUTFILLAEV, Sharafuddin	000 s2 / 000 s3 [05:00]
	FOCA, Nicolae	MDA	2	GERCHEV, Yanislav	18	GERCHEV, Yanislav	000 / 100 [01:29]
	GERCHEV, Yanislav	BUL					
	CHKHVIMIANI, Lukhumi	GEO	3	CHKHVIMIANI, Lukhumi	19	CHKHVIMIANI, Lukhumi	100 s1 / 000 [01:10]
	BARTHA, Akos	HUN					
	CARLOS JUNIOR, Artur	MOZ	4	JAFY, Mohamed	20	JAFY, Mohamed	000 / 100 [00:14]
	JAFY, Mohamed	MAR					

Pool B

	UROZBOEV, Diyorbek	UZB	5	UROZBOEV, Diyorbek	19	GARRIGOS, Francisco	000 / 101 [04:46]
	BAGIROV, Arif	BLR					
	SZABO, Csaba	HUN	6	GARRIGOS, Francisco	20	IMASHEV, Aibek	000 s1 / 100 [04:36]
	GARRIGOS, Francisco	ESP					
	MCKENZIE, Ashley	GBR	7	CARVALHO, Nuno	21	IMASHEV, Aibek	001 s4 / 100 s1 [04:58]
	CARVALHO, Nuno	POR					
	IMASHEV, Aibek	KAZ	8	IMASHEV, Aibek	22	IMASHEV, Aibek	002 / 000 s1 [05:00]
	BESTAEV, Otar	KGZ					

Pool C

	SMETOV, Yeldos	KAZ	9	SMETOV, Yeldos	21	SMETOV, Yeldos	010 / 010 s2 [05:00]
	KULIKOV, Dmitriy	RUS	10	KULIKOV, Dmitriy	22	SMETOV, Yeldos	100 / 000 [04:19]
	KABA, Ahmet Sahin	TUR					
	PETRIKOV, Pavel	CZE	11	PETRIKOV, Pavel	23	PETRIKOV, Pavel	000 s1 / 000 s3 [05:00]
	REINVALL, Juho	FIN					
	MAJRASHI, Eisa	KSA	12	MAJRASHI, Eisa	24	PETRIKOV, Pavel	100 / 000 s1 [03:30]

Pool D

	SHISHIME, Toru	JPN	13	SHISHIME, Toru	23	SHISHIME, Toru	101 / 000 [02:53]
	CULLHAJ, Indrit	ALB	14	KUNIHURO, Aaron	24	SHISHIME, Toru	000 s2 / 101 s1 [02:41]
	KUNIHURO, Aaron	USA					
	TSAI, Ming Yen	TPE	15	TSAI, Ming Yen	25	SHISHIME, Toru	110 s1 / 000 s3 [02:44]
	PETKA, Roland	HUN					
	AN, Jianqi	CHN	16	GUEDEZ, Javier	26	SHISHIME, Toru	000 s1 / 100 [02:53]
	GUEDEZ, Javier	VEN					

Repechage

	CHKHVIMIANI, Lukhumi	GEO	29	GARRIGOS, Francisco	33	SHISHIME, Toru	000 / 100 [03:10]
	GARRIGOS, Francisco	ESP					
	PETRIKOV, Pavel	CZE	30	TSAI, Ming Yen	34	LUTFILLAEV, Sharafuddin	000 / 101 s2 [04:20]
	TSAI, Ming Yen	TPE					
	LUTFILLAEV, Sharafuddin	UZB					

SMETOV, Yeldos 35  
000 s2 / 101 s2 [04:40]

SMETOV, Yeldos 32  
010 s2 / 000 [05:00]

## Results

- SMETOV, Yeldos KAZ
- IMASHEV, Aibek KAZ
- SHISHIME, Toru JPN
- LUTFILLAEV, Sharafuddin UZB
- GARRIGOS, Francisco ESP
- TSAI, Ming Yen TPE
- CHKHVIMIANI, Lukhumi GEO
- PETRIKOV, Pavel CZE





# Judo Grand-Prix Budapest 2015

(HUN Budapest, 13-14 June 2015)

# -66 kg

41 Judoka

Pool A

SOBIROV, Rishod	UZB	1	SOBIROV, Rishod	33	SOBIROV, Rishod	011 s1 / 000 s1 [05:00]
BALATKHANOV, Vadoud	FIN	2	ZAMBORI, Bence	33		000 s1 / 000 [05:00]
ZAMBORI, Bence	HUN					
HAMAD, Sulaiman	KSA	3	HAMAD, Sulaiman	34	SOBIROV, Rishod	010 s1 / 000 [05:00]
URIARTE, Gar	ESP	4	URIARTE, Gar	34		000 s1 / 100 [02:23]
MA, Duanbin	CHN	5	MA, Duanbin	35		100 / 000 s1 [04:06]
BASILE, Fabio	ITA	6	BASILE, Fabio	35		001 s3 / 000 s1 [05:00]
CESAR, Diogo	POR					
SHIRINLI, Vugar	AZE	7	SHIRINLI, Vugar	36	MA, Duanbin	100 s1 / 000 s1 [04:21]
JEREB, Andraz	SLO	8	JEREB, Andraz	36		000 s1 / 101 s2 [04:47]

Pool B

LAROSE, David	FRA	9	LAROSE, David	37	LAROSE, David	100 / 000 [03:12]
HAGYO, Gabor	HUN	10	TIEFRABER, Andreas	37		001 s1 / 100 [02:45]
TIEFRABER, Andreas	AUT					
ABDULZHALILOV, Abdula	RUS	11	ABDULZHALILOV, Abdula	38	LAROSE, David	010 s2 / 001 [05:00]
ABDELMAWGOUD, Mohamed	EGY	12	ABDELMAWGOUD, Mohamed	38		100 s1 / 000 [04:50]
LEFEVERE, Jasper	BEL	13	LEFEVERE, Jasper	39	SMAGULOV, Zhansay	000 s2 / 001 s2 [05:00]
KEEBLE, Lewis	GBR	14	KEEBLE, Lewis	39		000 / 100 [00:06]
LOFORTE, Kevin	MOZ	15	LOFORTE, Kevin	39		010 s1 / 000 s2 [05:00]
CIGANOVIC, Ilija	SRB	15	CIGANOVIC, Ilija	40		000 s2 / 100 s2 [04:11]
SMAGULOV, Zhansay	KAZ	16	SMAGULOV, Zhansay	40		

Pool C

SEIDL, Sebastian	GER	17	SEIDL, Sebastian	41	SEIDL, Sebastian	100 / 000 [00:11]
BASSOU, Imad	MAR	18	BASSOU, Imad	41		100 s1 / 001 [03:32]
BOLEN, Bradford	USA					
MATEO, Wander	DOM	19	MATEO, Wander	42	SEIDL, Sebastian	000 s1 / 000 s2 [05:00]
VUKICEVIC, Marko	SRB	20	VUKICEVIC, Marko	42		000 / 100 s2 [02:19]
GOMBOC, Adrian	SLO	21	GOMBOC, Adrian	43		000 s2 / 000 s1 [05:36]
HOLIKULOV, Dostonjon	UZB	22	HOLIKULOV, Dostonjon	43		000 s2 / 100 s1 [01:18]
SZOKE, Laszlo	ROU	23	MAJER, Tibor	44	MUKANOV, Azamat	000 / 100 s1 [02:17]
MAJER, Tibor	HUN					
MUKANOV, Azamat	KAZ	24	MUKANOV, Azamat	44		

Pool D

BOUCHARD, Antoine	CAN	25	BOUCHARD, Antoine	45	BOUCHARD, Antoine	003 s1 / 000 [05:00]
AMU, Erchaogetu	CHN	26	AMU, Erchaogetu	45		001 s1 / 000 s2 [05:00]
BURNS, Nathon	GBR					
OLEINIC, Sergiu	POR	27	OLEINIC, Sergiu	46	OLEINIC, Sergiu	000 s3 / 101 [04:53]
SANDAL, Sinan	TUR	28	SANDAL, Sinan	46		000 s2 / 000 s3 [05:00]
FLICKER, Tal	ISR	29	FLICKER, Tal	47	GALSTYAN, Arsen	000 s2 / 101 [04:01]
MATTEY, Sergio	VEN	30	MATTEY, Sergio	47		100 / 000 s1 [02:33]
MANJATE, Alfredo	MOZ					
GALSTYAN, Arsen	RUS	31	GALSTYAN, Arsen	48		101 s1 / 000 [02:53]
MARGVELASHVILI, Vazha	GEO	32	MARGVELASHVILI, Vazha	48		101 s1 / 001 s1 [03:58]
ORI, Felician	HUN					

Repechage

MA, Duanbin	CHN	61	LAROSE, David	65	GALSTYAN, Arsen	000 / 010 s3 [05:00]
LAROSE, David	FRA					000 s2 / 101 [04:46]
	RUS					
MUKANOV, Azamat	KAZ	62	OLEINIC, Sergiu	66	OLEINIC, Sergiu	014 / 100 s1 [04:43]
OLEINIC, Sergiu	POR					100 / 000 [00:00]
	UZB					

SMAGULOV, Zhansay 67  
000 s1 / 000 s3 [05:00]

SEIDL, Sebastian 64  
100 s1 / 001 [03:12]

## Results

- SMAGULOV, Zhansay KAZ
- SEIDL, Sebastian GER
- GALSTYAN, Arsen RUS
- OLEINIC, Sergiu POR
- LAROSE, David FRA
- SOBIROV, Rishod UZB
- MA, Duanbin CHN
- MUKANOV, Azamat KAZ







# Judo Grand-Prix Budapest 2015

(HUN Budapest, 13-14 June 2015)

**-73 kg**  
45 Judoka

**Pool A**

DRAKSIC, Rok	SLO	1	DRAKSIC, Rok	33	DRAKSIC, Rok	111 s2 / 000 [03:47]
VAN T WESTENDE, Sam	NED	2	VAN T WESTENDE, Sam	100 / 001 [02:30]		
AZOIDIS, Georgios	GRE				49	DRAKSIC, Rok
WILLIAMS, Daniel	GBR	3	WILLIAMS, Daniel			
HOSNYANSZKI, Daniel	HUN	4	PLIYEV, Sergiy	000 / 100 [00:27]	34	WILLIAMS, Daniel
PLIYEV, Sergiy	UKR					
YKYBAYEV, Dastan	KAZ	5	YKYBAYEV, Dastan			
WANDTKE, Igor	GER	6	WANDTKE, Igor	000 s1 / 010 s3 [05:00]	35	WANDTKE, Igor
GARDASEVIC, Nikola	MNE	7	VANLIOGLU, Hasan	000 s2 / 002 s2 [05:00]		
VANLIOGLU, Hasan	TUR				36	VANLIOGLU, Hasan
BRIAND, Etienne	CAN	8	BRIAND, Etienne	000 s2 / 000 s3 [05:00]		

**Pool B**

DELPOPOLO, Nicholas	USA	9	DELPOPOLO, Nicholas			
ALHARBI, Mohammed	KSA	10	SUN, Shuai	000 / 101 [02:35]	37	DELPOPOLO, Nicholas
SUN, Shuai	CHN					
SANTANA, Lwilli	DOM	11	SANTANA, Lwilli			
JURACSEK, Laszlo	HUN	12	ALVES, Andre	000 s3 / 000 [05:00]	38	ALVES, Andre
ALVES, Andre	POR					
BENSTED, Jake	AUS	13	BENSTED, Jake			
UEMATSU, Kiyoshi	ESP	14	KURZHEV, Uali	000 s2 / 000 s1 [05:00]		
KURZHEV, Uali	RUS				39	KURZHEV, Uali
JEZEK, Jaromir	CZE	15	JEZEK, Jaromir			
SHARIPOV, Mirali	UZB	16	SHARIPOV, Mirali	001 s3 / 000 s2 [05:00]	40	JEZEK, Jaromir

**Pool C**

VAN TICHEL, Dirk	BEL	17	VAN TICHEL, Dirk			
SAI, Yinjirigala	CHN	18	SAI, Yinjirigala	000 s1 / 000 s2 [05:00]	41	VAN TICHEL, Dirk
TORENOV, Yertugan	KAZ	19	TORENOV, Yertugan	010 s2 / 000 s1 [05:00]		
MARGELIDON, Arthur	CAN				42	SZABO, Frigyes
SZABO, Frigyes	HUN	20	SZABO, Frigyes	000 s1 / 100 [04:32]		
ESTRADA, Magdiel	CUB	21	ESTRADA, Magdiel			
BURLAC, Dan	MDA	22	VOELK, Christopher	000 s1 / 010 [05:00]	43	ESTRADA, Magdiel
VOELK, Christopher	GER					
SARAIVA, Nuno	POR	23	SARAIVA, Nuno			
MIRANDA, Augusto	PUR	24	MIRANDA, Augusto	000 s1 / 001 s2 [05:00]	44	MIRANDA, Augusto
HEBO, Pedro	ANG					

**Pool D**

UNGVARI, Miklos	HUN	25	UNGVARI, Miklos			
GOSIEWSKI, Jan	GBR	26	GOSIEWSKI, Jan	110 s1 / 000 s1 [03:25]	45	UNGVARI, Miklos
GUSIC, Nikola	MNE					
THIBLIN, Martin	NOR	27	SANCHEZ MONDACA, Diego	000 s2 / 100 s2 [05:18]		
SANCHEZ MONDACA, Diego	ESP				46	SANCHEZ MONDACA, Diego
MADEIRA, Edson	MOZ	28	MADEIRA, Edson	010 s2 / 000 s2 [05:00]		
		29				
NARTEY, Emmanuel	GHA	30	GADANOV, Alim	000 s3 / 010 [05:00]	47	GADANOV, Alim
GADANOV, Alim	RUS					
MACIAS, Tommy	SWE	31	MACIAS, Tommy			
LAAMANEN, Eetu	FIN	32	BOLTABOEV, Sharofiddin	000 s1 / 111 s1 [04:15]	48	MACIAS, Tommy
BOLTABOEV, Sharofiddin	UZB					

**Repechage**

WANDTKE, Igor	GER	61	WANDTKE, Igor	000 / 000 s1 [05:00]		
JEZEK, Jaromir	CZE				65	VAN TICHEL, Dirk
			VAN TICHEL, Dirk	000 / 100 s1 [02:54]		
ESTRADA, Magdiel	CUB	62	MACIAS, Tommy	000 / 101 [01:12]		
MACIAS, Tommy	SWE				66	DELPOPOLO, Nicholas
			DELPOPOLO, Nicholas	000 s2 / 010 s1 [05:00]		

UNGVARI, Miklos  
000 s2 / 101 s1 [04:10] **67**

**63** DRAKSIC, Rok  
100 s2 / 000 s1 [04:15]

Results		
1.	UNGVARI, Miklos	HUN
2.	DRAKSIC, Rok	SLO
3.	VAN TICHEL, Dirk	BEL
5.	DELPOPOLO, Nicholas	USA
5.	WANDTKE, Igor	GER
7.	MACIAS, Tommy	SWE
7.	JEZEK, Jaromir	CZE
7.	ESTRADA, Magdiel	CUB





# Judo Grand-Prix Budapest 2015

(HUN Budapest, 13-14 June 2015)

# -81 kg

52 Judoka

Pool A

GER	MARESCH, Sven	1	MARESCH, Sven	33	MARESCH, Sven	000 / 000 s3 [5:00]
GRE	NTANATSIDIS, Alexios	2	NTANATSIDIS, Alexios	001 s2 / 000 [5:00]		
ESP	NACIMIENTO LORENZO, Adrian					
AUT	OTT, Marcel	3	OTT, Marcel	000 s1 / 000 s3 [5:00]		
KGZ	ZOLOEV, Vladimir					
CHN	ERI, Hemubatu	4	ERI, Hemubatu	000 / 100 [0:19]		
UZB	IMAMOV, Yakhyo	5	IMAMOV, Yakhyo			
HUN	UNGVARI, Attila	6	UNGVARI, Attila	100 / 000 s1 [1:55]		
NED	DE WIT, Frank					
SRB	MAJDOV, Stefan	7	IVANOV, Ivaylo	000 s3 / 000 s1 [5:00]		
BUL	IVANOV, Ivaylo					
MDA	OSLOBANU, Sergiu	8	OSLOBANU, Sergiu	100 / 000 s1 [1:51]		
ISL	IURA, Sveinbjorn					

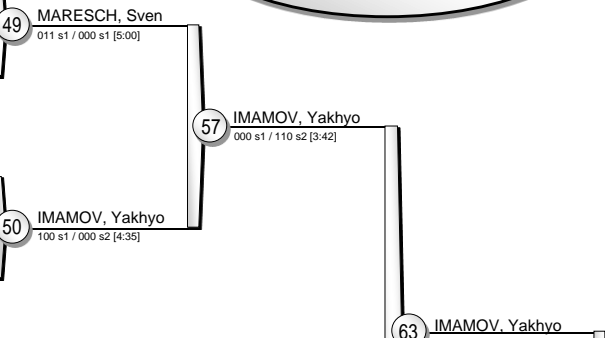

Pool B

HUN	CSOKNYAI, Laszlo	9	CSOKNYAI, Laszlo			
SLO	SEDEJ, Aljaz	10	MRVALJEVIC, Srdjan	000 s2 / 100 s1 [2:32]		
MNE	MRVALJEVIC, Srdjan					
DOM	NOVA ALCANTARA, Jose	11	KERMARREC, Julian	000 s1 / 100 s1 [2:29]		
FRA	KERMARREC, Julian					
EGY	HAZEM, Ali	12	LIVESEY, Owen	000 s1 / 001 s2 [5:00]		
GBR	LIVESEY, Owen					
SVK	MILICHOVSKY, Matus	14	MILICHOVSKY, Matus	002 s3 / 000 s2 [5:00]		
ISR	CHEN, Asaf					
ROU	MITITELU, Denis	15	LUZ, Carlos	000 / 100 [1:14]		
POR	LUZ, Carlos					
RUS	SEMENOV, Stanislav	16	SEMENOV, Stanislav	001 s1 / 010 s2 [5:00]		

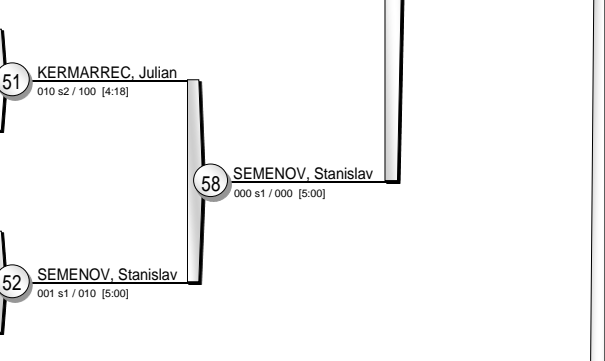

Pool C

HUN	KRIZSAN, Szabolcs	17	KRIZSAN, Szabolcs			
DOM	DEL ORBE CORTORREAL, Medickson	18	DEL ORBE CORTORREAL, Medickson	000 / 100 [0:43]		
FIN	VIRTA, Antti					
MDA	GOTONOAGA, Dorin	19	GOTONOAGA, Dorin	110 s2 / 000 s3 [5:00]		
ESP	KALABEGASHVILI, Shalva					
UZB	SOBIROV, Shaxzod	20	SOBIROV, Shaxzod	000 s1 / 010 s2 [5:00]		
FRA	SCHMITT, Alain	21	SCHMITT, Alain			
KAZ	IBRAGIMOV, Rinat	22	IBRAGIMOV, Rinat	101 / 000 [0:45]		
SWE	PACEK, Robin					
RUS	PSHMAKHOV, Arsen	23	PSHMAKHOV, Arsen	100 / 000 s1 [2:33]		
AUT	BUBANJA, Marko					
PUR	MIRANDA, Gadiel	24	DUDCHYK, Vitalii	000 s3 / 002 s1 [5:00]		
UKR	DUDCHYK, Vitalii					

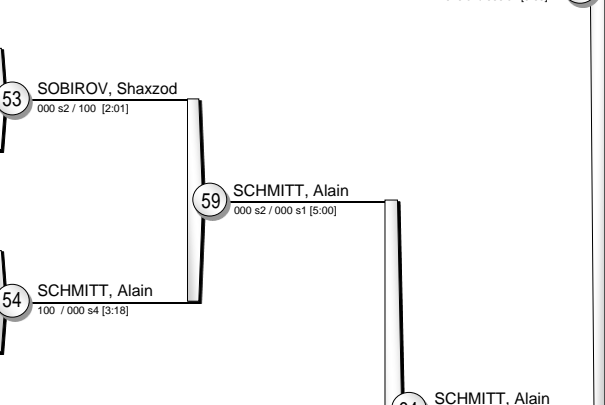

Pool D

GRE	MOUSTOPOULOS, Roman	25	MOUSTOPOULOS, Roman			
SLO	CETIC, Jesenko	26	MUSIL, Jaromir	000 s1 / 101 s2 [3:21]		
CZE	MUSIL, Jaromir					
EGY	ABDELAAL, Mohamed	27	ABDELAAL, Mohamed	100 / 001 s2 [2:13]		
EST	SALEJEV, Jevgeni					
KSA	ALBISHI, Abdalkarim	28	SILVA MORALES, Ivan Felipe	000 / 100 [0:28]		
CUB	SILVA MORALES, Ivan Felipe					
GER	WIECZERZAK, Alexander	29	WIECZERZAK, Alexander			
GBR	REED, Tom	30	REED, Tom	100 / 000 s1 [3:34]		
LTU	MAIBORODA, Arturas					
HUN	KOLLER, Milan	31	KOLLER, Milan			
POR	LIMA, Diogo	32	LIMA, Diogo	000 s1 / 101 [2:10]		
LAT	OVCHINIKOV, Konstantins					

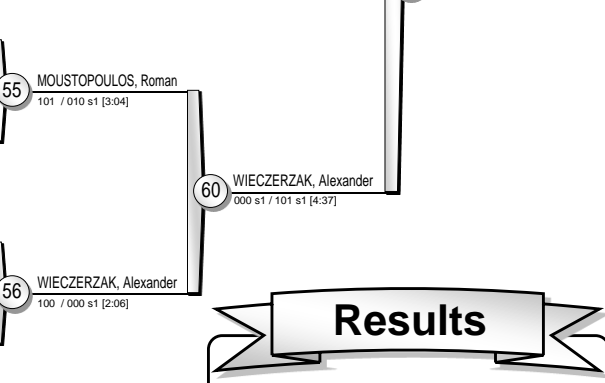

IMAMOV, Yakhyo 67  
010 s2 / 000 s2 [5:00]

Repechage

GER	MARESCH, Sven	61	MARESCH, Sven	000 / 000 s2 [5:00]		
FRA	KERMARREC, Julian					
GER	WIECZERZAK, Alexander	65	MARESCH, Sven	010 s3 / 000 s1 [5:00]		
UZB	SOBIROV, Shaxzod					
GRE	MOUSTOPOULOS, Roman	62	MOUSTOPOULOS, Roman	000 / 100 s1 [2:43]		
RUS	SEMENOV, Stanislav	66	MOUSTOPOULOS, Roman	000 s1 / 000 s2 [5:00]		

## Results

- IMAMOV, Yakhyo UZB
- SCHMITT, Alain FRA
- MARESCH, Sven GER
- MOUSTOPOULOS, Roman GRE
- WIECZERZAK, Alexander GER
- SEMENOV, Stanislav RUS
- KERMARREC, Julian FRA
- SOBIROV, Shaxzod UZB





# Judo Grand-Prix Budapest 2015

(HUN Budapest, 13-14 June 2015)

**-90 kg**  
38 Judoka

**Pool A**

	GONZALEZ, Asley	CUB	1	GONZALEZ, Asley	33	GONZALEZ, Asley	001 s2 / 000 s1 [5:00]
	NYMAN, Marcus	SWE	2	NYMAN, Marcus	33		
	BOLAT, Timur	KAZ	3	BOLAT, Timur	49	GONZALEZ, Asley	010 s2 / 000 s2 [5:00]
	BROWN, Colton	USA	4	BROWN, Colton	34	BROWN, Colton	000 s1 / 011 s3 [5:00]
	DIAS, Celio	POR	5	DIAS, Celio	57	DIAS, Celio	010 s1 / 100 [0:48]
	CHENG, Xunzhao	CHN	6	CHENG, Xunzhao	35	DIAS, Celio	100 / 000 s1 [1:50]
	RABAI, Laszlo	HUN	6	RABAI, Laszlo	50	DIAS, Celio	010 s3 / 001 s1 [5:00]
	EFEMGIL, Batuhan	TUR	7	EFEMGIL, Batuhan	36	ZGANK, Mihael	000 s3 / 001 s1 [5:00]
	ZGANK, Mihael	SLO	8	ZGANK, Mihael	36		

**Pool B**

	ODENTHAL, Marc	GER	9	ODENTHAL, Marc	37	ODENTHAL, Marc	101 / 000 s2 [3:10]
	GOMERA, Cristhian	DOM	10	GOMERA, Cristhian	37		
	MARCHITAN, Mihail	UAE	11	VIITANEN, Samuli	38	VIITANEN, Samuli	000 s3 / 000 [5:00]
	VIITANEN, Samuli	FIN	11	VIITANEN, Samuli	38		
	CHAMBERLAIN, Frazer	GBR	12	CHAMBERLAIN, Frazer	38	VIITANEN, Samuli	011 s1 / 000 s1 [5:00]
	NHABALI, Quedjau	UKR	13	NHABALI, Quedjau	39	NHABALI, Quedjau	100 / 001 [2:38]
	VER, Gabor	HUN	14	VER, Gabor	39		
	MARMELJUK, Aleksandr	EST	14	MARMELJUK, Aleksandr	52	NHABALI, Quedjau	111 s1 / 000 s1 [2:59]
	KHOLMAMATOV, Kamoliddin	UZB	15	KHOLMAMATOV, Kamoliddin	40	KHOLMAMATOV, Kamoliddin	011 s2 / 000 s1 [5:00]
	TEMESI, Sebastian	AUS	16	TEMESI, Sebastian	40		

**Pool C**

	JURAEV, Serali	UZB	17	JURAEV, Serali	41	JURAEV, Serali	101 / 000 s4 [2:51]
	FLORENTINO, Robert	DOM	18	OHAT, Zalan	41	OHAT, Zalan	000 / 100 s1 [1:09]
	OHAT, Zalan	HUN	18	OHAT, Zalan	41		
	ALLI, Jaakko	FIN	19	ALLI, Jaakko	42	KOCHMAN, Li	000 s1 / 101 [2:23]
	KOCHMAN, Li	ISR	20	KOCHMAN, Li	42		
	ABDELLAOUI, Imad	MAR	21	ABDELLAOUI, Imad	43	BUFFET, Romain	001 s2 / 010 s2 [5:00]
	BUFFET, Romain	FRA	22	BUFFET, Romain	43		
	VAN NUFFEL, Dylan	BEL	22	VAN NUFFEL, Dylan	54	BUFFET, Romain	101 s1 / 000 s2 [3:55]
	MILENBERGS, Aigars	LAT	23	MILENBERGS, Aigars	44	MARTINEZ, Nelson	000 s3 / 000 s2 [5:00]
	MARTINEZ, Nelson	VEN	24	MARTINEZ, Nelson	44		

**Pool D**

	DVARBY, Joakim	SWE	25	DVARBY, Joakim	45	RANDL, Milan	000 s3 / 000 s2 [5:00]
	RANDL, Milan	SVK	26	RANDL, Milan	45		
	BURNS, Andrew	GBR	27	BURNS, Andrew	46	MAGOMEDOV, Magomed	000 s1 / 001 s3 [5:00]
	MAGOMEDOV, Magomed	RUS	28	MAGOMEDOV, Magomed	46		
	HILDEBRAND, Aaron	GER	29	HILDEBRAND, Aaron	47	HILDEBRAND, Aaron	101 s3 / 010 s1 [3:34]
	KERSICS, David	HUN	30	SYNYAVSKY, Vadym	47	SYNYAVSKY, Vadym	000 s2 / 101 s2 [4:48]
	SYNYAVSKY, Vadym	UKR	30	SYNYAVSKY, Vadym	47		
	SHERAZADISHVILI, Nikoloz	ESP	31	SHERAZADISHVILI, Nikoloz	48	BOZBAYEV, Islam	001 / 011 s3 [5:00]
	BOZBAYEV, Islam	KAZ	32	BOZBAYEV, Islam	48		

**Repechage**

	GONZALEZ, Asley	CUB	61	GONZALEZ, Asley	65	GONZALEZ, Asley	101 s1 / 000 [4:25]
	NHABALI, Quedjau	UKR	61	NHABALI, Quedjau	65		
	RANDL, Milan	SVK	65	RANDL, Milan	65		
	KOCHMAN, Li	ISR	62	KOCHMAN, Li	66	KOCHMAN, Li	110 / 000 s1 [2:29]
	BOZBAYEV, Islam	KAZ	62	BOZBAYEV, Islam	66		
	ODENTHAL, Marc	GER	66	ODENTHAL, Marc	66		

DIAS, Celio  
010 s3 / 000 s1 [5:00] **67**

BUFFET, Romain  
000 s3 / 000 s1 [5:00] **64**

## Results

- DIAS, Celio POR
- BUFFET, Romain FRA
- GONZALEZ, Asley CUB
- KOCHMAN, Li ISR
- RANDL, Milan SVK
- ODENTHAL, Marc GER
- NHABALI, Quedjau UKR
- BOZBAYEV, Islam KAZ





# Judo Grand-Prix Budapest 2015

(HUN Budapest, 13-14 June 2015)

# -100 kg

34 Judoka

Pool A

GER	PETERS, Dimitri	1
ESP	SAN MARTIN CARRERA, Alejandro	2
GBR	AWITIALCARAZ, Philip	3
SEN	MANE, Baboukar	4
UAE	REMARENCO, Ivan	5
ROU	RADU, Valentin	6
UKR	CHERKASOV, Mykhailo	7
MNE	PANTIC, Danilo	8

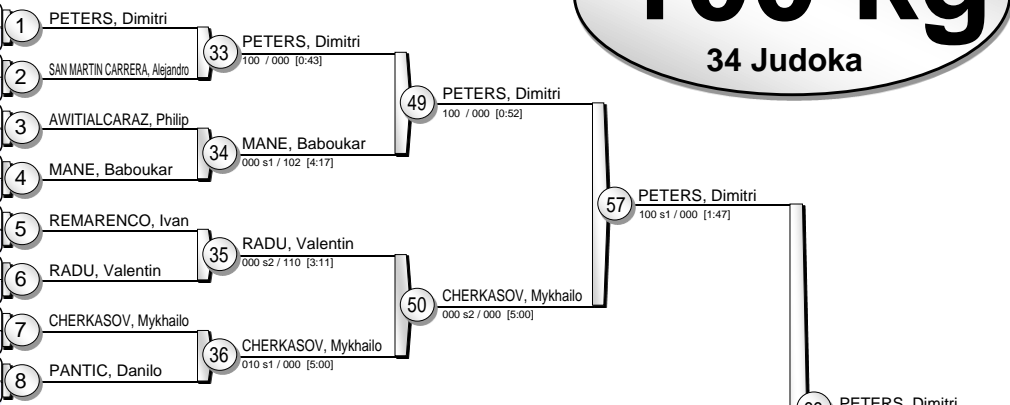

Pool B

SWE	PACEK, Martin	9
HUN	CIRJENICS, Miklos	10
SRB	JURISIC, Stefan	11
VEN	PENA, Anthoni	12
GEO	MSKHALADZE, Aleksandre	13
CUB	ARMENTEROS, Jose	14
RUS	KHAIBULAEV, Tagir	15
SLO	SPASOJEVIC, Igor	16
CRO	KUMRIC, Zlatko	17

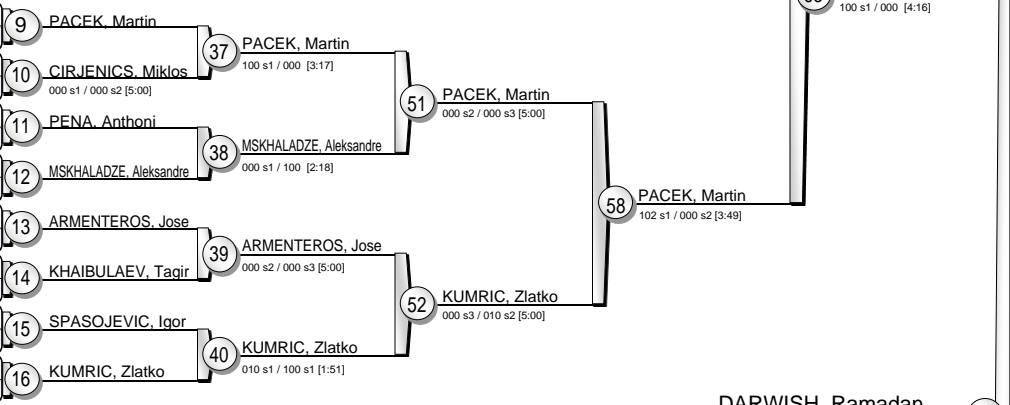

Pool C

RUS	BISULTANOV, Adlan	17
POR	FONSECA, Jorge	18
LTU	LEKAVICIUS, Zilvinas	19
CHN	HU, Kai	20
TJK	SAIDOV, Saidzhalol	21
UKR	BLOSHENKO, Artem	22
LAT	BORODAVKO, Jevgenijs	23
HUN	BREITENBACH, Paul	24
KAZ	DEMYANENKO, Viktor	25

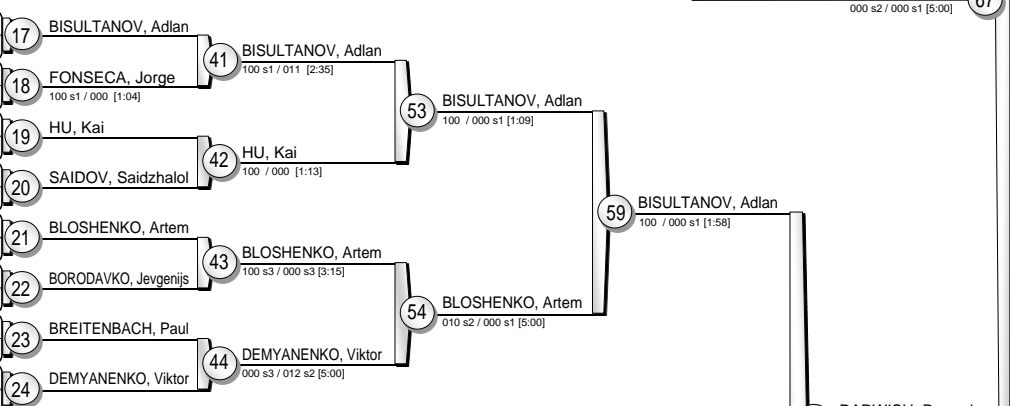

Pool D

EGY	DARWISH, Ramadan	25
TUR	TURAN, Timur	26
EST	MINASKIN, Grigori	27
GEO	ZAALISHVILI, Aleksandre	28
UZB	SAYIDOV, Ramziddin	29
AUT	HAGENER, Maximilian	30
DEN	JOERGENSEN, Frederik	31
USA	IMINOV, Akbarzhan	32

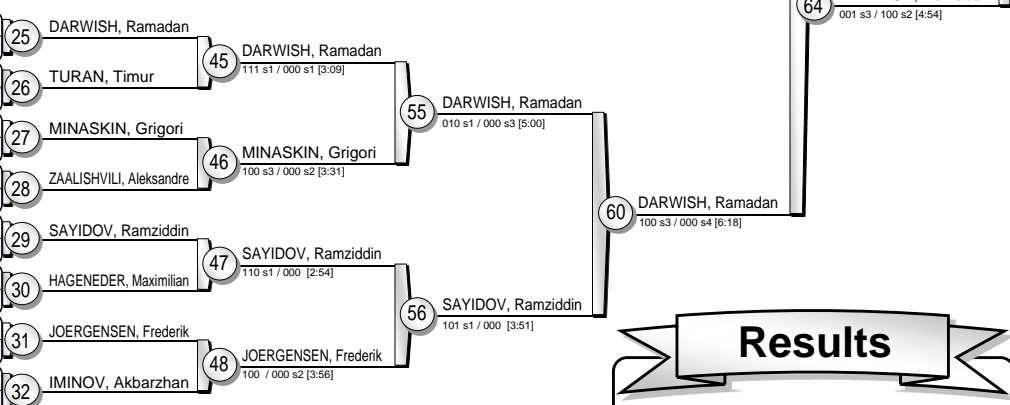

DARWISH, Ramadan 000 s2 / 000 s1 [5:00] 67

DARWISH, Ramadan 001 s3 / 100 s2 [4:54] 64

Repechage

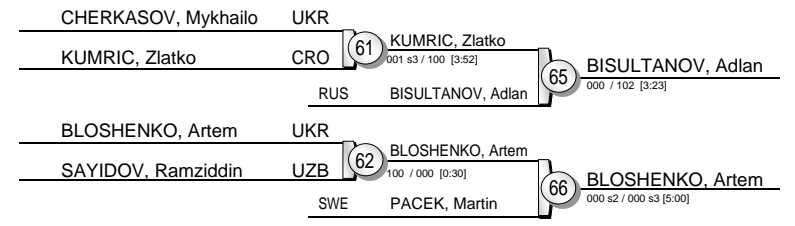

## Results

1.	DARWISH, Ramadan	EGY
2.	PETERS, Dimitri	GER
3.	BISULTANOV, Adlan	RUS
3.	BLOSHENKO, Artem	UKR
5.	KUMRIC, Zlatko	CRO
5.	PACEK, Martin	SWE
7.	CHERKASOV, Mykhailo	UKR
7.	SAYIDOV, Ramziddin	UZB



# Judo Grand-Prix Budapest 2015

(HUN Budapest, 13-14 June 2015)

# +100 kg

26 Judoka

Pool A

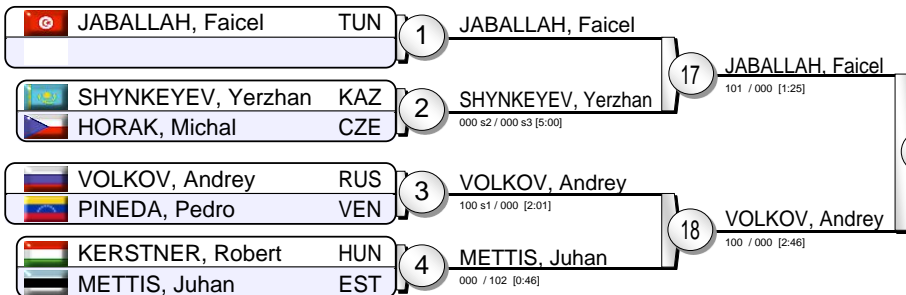

Pool B

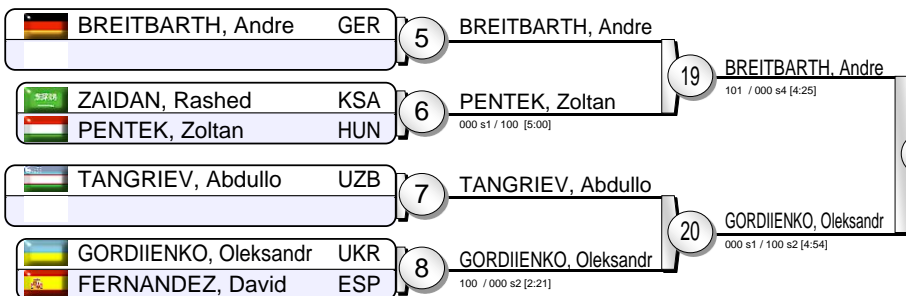

Pool C

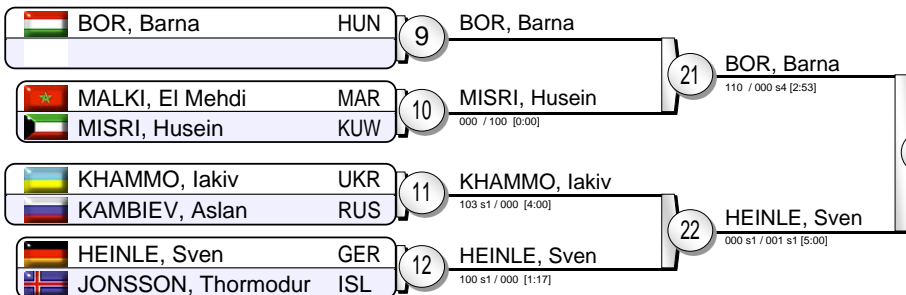

Pool D

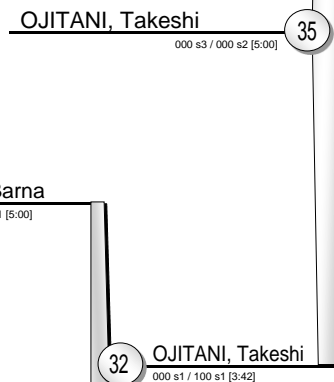
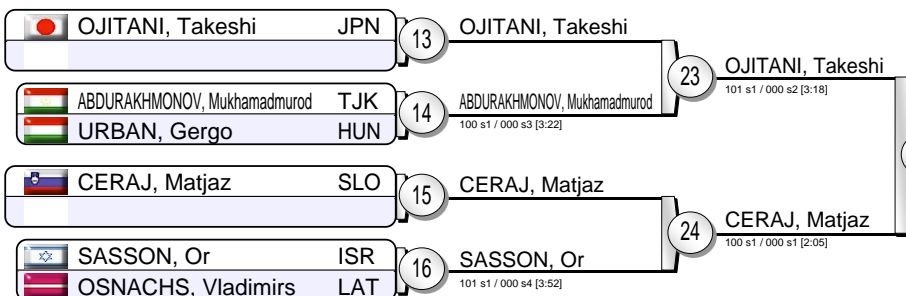

Repechage

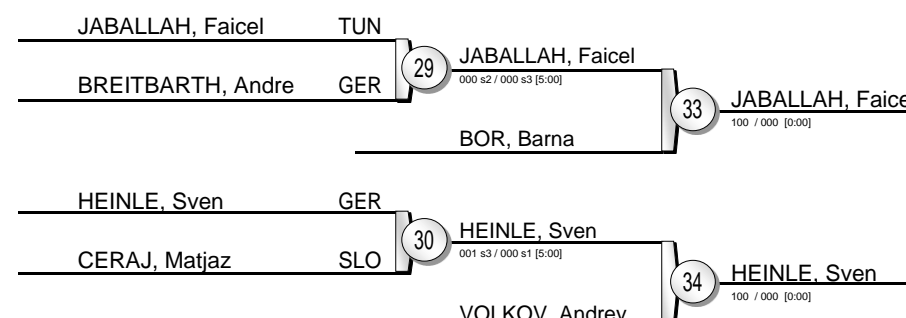

## Results

- OJITANI, Takeshi JPN
- GORDIENKO, Oleksandr UKR
- JABALLAH, Faicel TUN
- HEINLE, Sven GER
- BOR, Barna HUN
- VOLKOV, Andrey RUS
- BREITBARTH, Andre GER
- CERAJ, Matjaz SLO





# Judo Grand-Prix Budapest 2015

(HUN Budapest, 13-14 June 2015)

# -48 kg

19 Judoka

Pool A

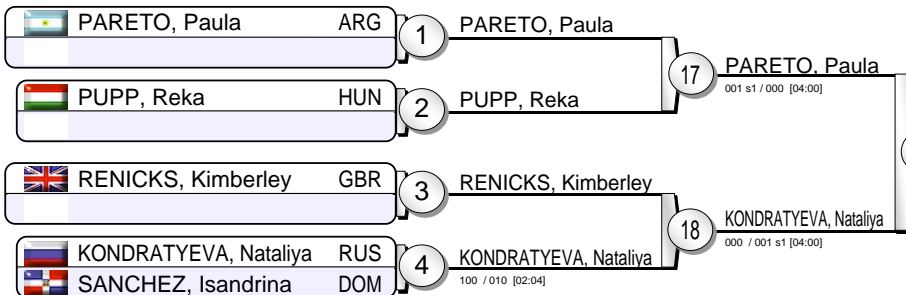

Pool B

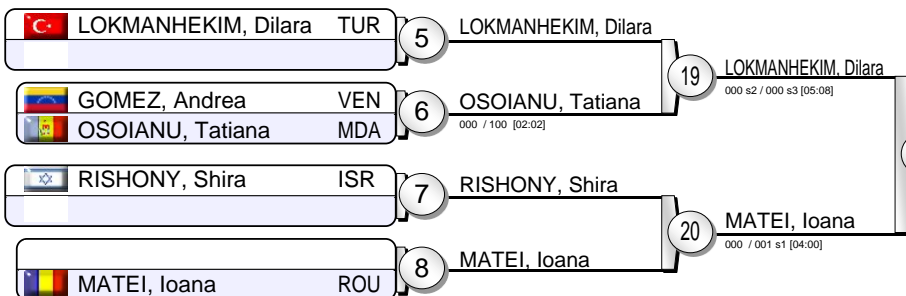

Pool C

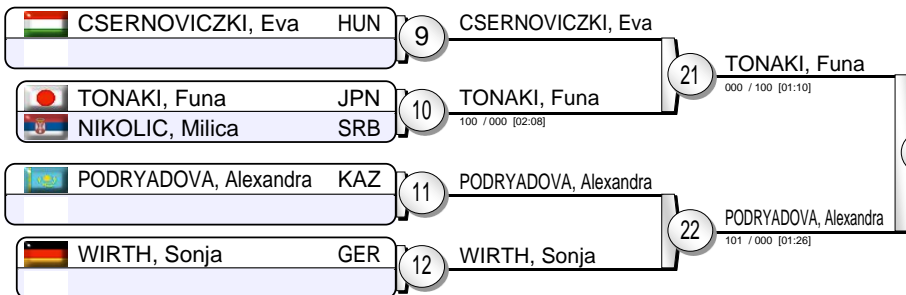

Pool D

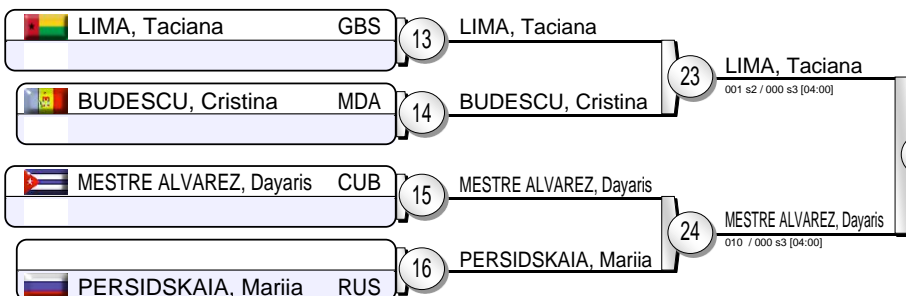

PARETO, Paula (ARG) vs LOKMANHEKIM, Dilara (TUR) - Match 31

TONAKI, Funa (JPN) vs MESTRE ALVAREZ, Dayaris (CUB) - Match 32

PARETO, Paula (ARG) vs TONAKI, Funa (JPN) - Match 35

Repechage

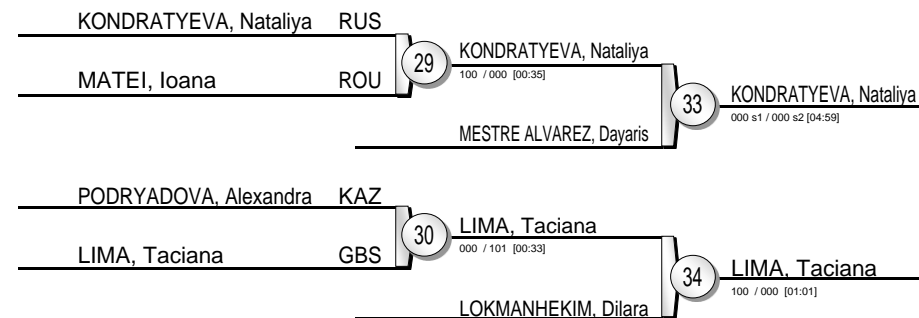

## Results

- PARETO, Paula (ARG)
- TONAKI, Funa (JPN)
- KONDRATYEVA, Nataliya (RUS)
- LIMA, Taciana (GBS)
- MESTRE ALVAREZ, Dayaris (CUB)
- LOKMANHEKIM, Dilara (TUR)
- MATEI, Ioana (ROU)
- PODRYADOVA, Alexandra (KAZ)





# Judo Grand-Prix Budapest 2015

(HUN Budapest, 13-14 June 2015)

# -52 kg

21 Judoka

Pool A

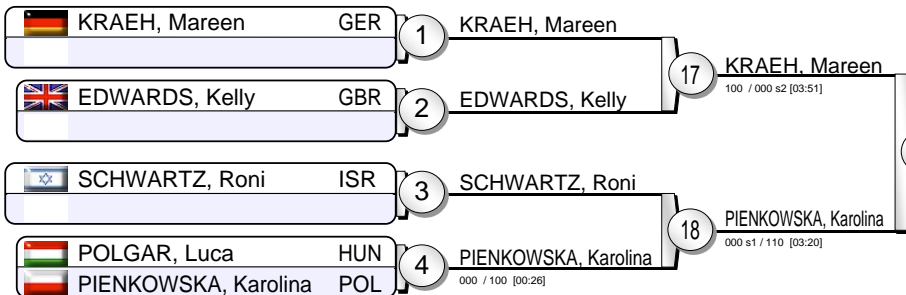

Pool B

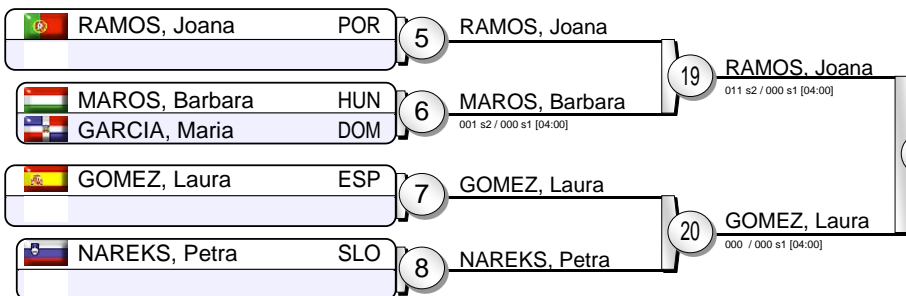

Pool C

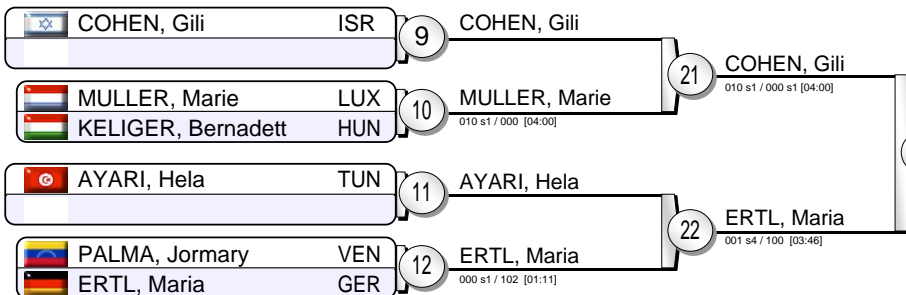

Pool D

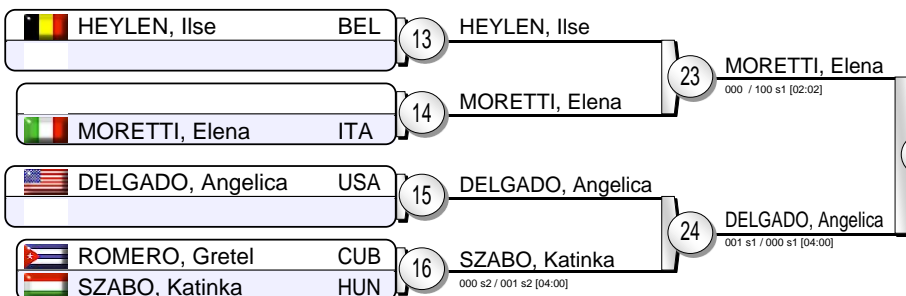

KRAEH, Mareen 35  
001 s1 / 000 [04:00]

ERTL, Maria 32  
001 s1 / 000 s1 [04:00]

## Results

1. KRAEH, Mareen GER
2. ERTL, Maria GER
3. GOMEZ, Laura ESP
3. RAMOS, Joana POR
5. MORETTI, Elena ITA
5. COHEN, Gili ISR
7. PIENKOWSKA, Karolina POL
7. DELGADO, Angelica USA

Repechage

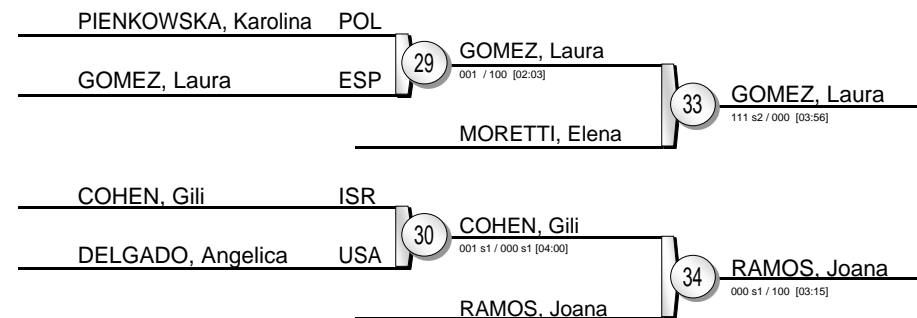



# Judo Grand-Prix Budapest 2015

(HUN Budapest, 13-14 June 2015)

# -57 kg

24 Judoka

Pool A

	MALLOY, Marti	USA	1	MALLOY, Marti	17
	CENTRACCHIO, Maria	ITA	2	EQUISOAIN, Jaione	17
	EQUISOAIN, Jaione	ESP			
	MINAKAWA, Camila	ISR	3	MINAKAWA, Camila	18
	SIROKI, Ibolya	HUN	4	BOZOVIC, Tanja	18
	BOZOVIC, Tanja	MNE			

Pool B

	BEDETI, Vlora	SLO	5	BEDETI, Vlora	19
	DIEDHIOU, Hortance	SEN	6	DIEDHIOU, Hortance	19
	DURBACH, Manon	LUX			
	LIEN, Chen-Ling	TPE	7	LIEN, Chen-Ling	20
	KNETIG, Eموke	HUN	8	KNETIG, Eموke	20
	JIMENEZ, Luisa	DOM			

Pool C

	ROPER, Miryam	GER	9	ROPER, Miryam	21
	LO GIUDICE, Martina	ITA	10	KAZENYUK, Tatiana	21
	KAZENYUK, Tatiana	RUS			
	WAECHTER, Viola	GER	11	WAECHTER, Viola	22
	CARMICHAEL, Hana	USA	12	CARMICHAEL, Hana	22
	RAMSAY, Connie	GBR			

Pool D

	KARAKAS, Hedvig	HUN	13	KARAKAS, Hedvig	23
	RAHMING, Cynthia	BAH	14	BARRIOS, Anriquelis	23
	BARRIOS, Anriquelis	VEN			
	ILIEVA, Ivelina	BUL	15	ILIEVA, Ivelina	24
	BELLORIN, Concepcion	ESP	16	TAMAOKI, Momo	24
	TAMAOKI, Momo	JPN			

Repechage

	MINAKAWA, Camila	ISR	29	MINAKAWA, Camila	33
	DIEDHIOU, Hortance	SEN			
				TAMAOKI, Momo	
	ROPER, Miryam	GER	30	KARAKAS, Hedvig	34
	KARAKAS, Hedvig	HUN			
				MALLOY, Marti	

## Results

- |    |                    |     |
|----|--------------------|-----|
| 1. | LIEN, Chen-Ling    | TPE |
| 2. | WAECHTER, Viola    | GER |
| 3. | TAMAOKI, Momo      | JPN |
| 3. | MALLOY, Marti      | USA |
| 5. | MINAKAWA, Camila   | ISR |
| 5. | KARAKAS, Hedvig    | HUN |
| 7. | DIEDHIOU, Hortance | SEN |
| 7. | ROPER, Miryam      | GER |







# Judo Grand-Prix Budapest 2015

(HUN Budapest, 13-14 June 2015)

# -63 kg

26 Judoka

Pool A

	TRSTENJAK, Tina	SLO	1	TRSTENJAK, Tina	17	TRSTENJAK, Tina	101 / 000 s2 [03:55]
	MIHOVICS, Szabina	HUN	2	CACHOLA, Ana	17		000 s1 / 100 [02:21]
	CACHOLA, Ana	POR	2				
	AKIYAMA, Leilani	USA	3	AKIYAMA, Leilani	18		001 s2 / 000 [04:00]
	WEZEU DOMBEU, Helene	CMR	3				
	HERRMANN, Vivian	GER	4	BERNHOLM, Anna	18		000 / 100 [00:31]
	BERNHOLM, Anna	SWE	4				000 s1 / 001 s1 [04:44]

25 TRSTENJAK, Tina  
000 / 000 s2 [04:00]

31 TRSTENJAK, Tina  
101 / 000 s1 [03:58]

Pool B

	LABAZINA, Marta	RUS	5	LABAZINA, Marta	19	LABAZINA, Marta	000 / 000 s1 [04:00]
	KATIPOGLU, Busra	TUR	6	KATIPOGLU, Busra	19		100 s1 / 010 s2 [04:00]
	KRSSAKOVA, Magdalena	AUT	6				
	PUCHE, Isabel	ESP	7	PUCHE, Isabel	20		
	MISKOVIC, Marijana	CRO	8	SZABO, Franciska	20		000 s1 / 100 s1 [04:08]
	SZABO, Franciska	HUN	8				000 s1 / 100 [03:13]

26 LABAZINA, Marta  
100 / 000 s1 [01:41]

35 TRSTENJAK, Tina  
101 / 000 s1 [03:52]

Pool C

	HAECKER, Katharina	AUS	9	HAECKER, Katharina	21	HAECKER, Katharina	000 / 000 s2 [04:00]
	ARTEAGA, Maria	VEN	10	TANAKA, Miki	21		001 / 100 s2 [02:17]
	TANAKA, Miki	JPN	10				
	MARTIN, Hannah	USA	11	KOMLOSIOVA, Ivana	22		000 / 100 [00:44]
	KOMLOSIOVA, Ivana	SVK	11				
	SURAKATOVA, Pari	RUS	12	SURAKATOVA, Pari	22		100 / 000 [00:07]
	POLYAK, Krisztina	HUN	12				

27 SURAKATOVA, Pari  
000 s1 / 100 [02:05]

32 SURAKATOVA, Pari  
100 / 000 s1 [02:56]

Pool D

	ZOUAK, Rizlen	MAR	13	ZOUAK, Rizlen	23	ZOUAK, Rizlen	000 s1 / 000 s3 [04:00]
	DEL TORO CARVAJAL, Maylin	CUB	14	SZOGEDI, Szandra	23		000 s2 / 012 s2 [04:00]
	SZOGEDI, Szandra	GHA	14				
	HERMANSSON, Mia	SWE	15	HERMANSSON, Mia	24		
	URDABAYEVA, Marian	KAZ	16	BAZYNSKI, Nadja	24		110 / 000 s1 [01:34]
	BAZYNSKI, Nadja	GER	16				001 / 011 s2 [04:00]

28 ZOUAK, Rizlen  
100 / 000 [01:48]

Repechage

	BERNHOLM, Anna	SWE	29	BERNHOLM, Anna	33	BERNHOLM, Anna	100 / 000 [02:17]
	SZABO, Franciska	HUN	29				
				ZOUAK, Rizlen	33		103 s1 / 000 [03:35]
	HAECKER, Katharina	AUS	30	HERMANSSON, Mia	34		000 s1 / 010 s2 [04:00]
	HERMANSSON, Mia	SWE	30				
				LABAZINA, Marta	34		001 s1 / 000 s3 [04:00]

## Results

- TRSTENJAK, Tina SLO
- SURAKATOVA, Pari RUS
- BERNHOLM, Anna SWE
- HERMANSSON, Mia SWE
- ZOUAK, Rizlen MAR
- LABAZINA, Marta RUS
- SZABO, Franciska HUN
- HAECKER, Katharina AUS





# Judo Grand-Prix Budapest 2015

(HUN Budapest, 13-14 June 2015)

# -70 kg

21 Judoka

Pool A

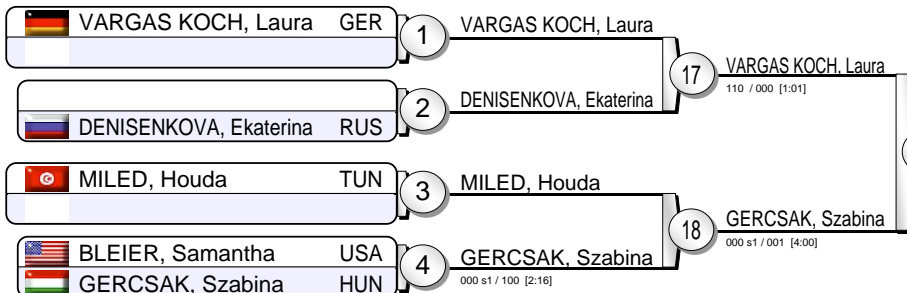

Pool B

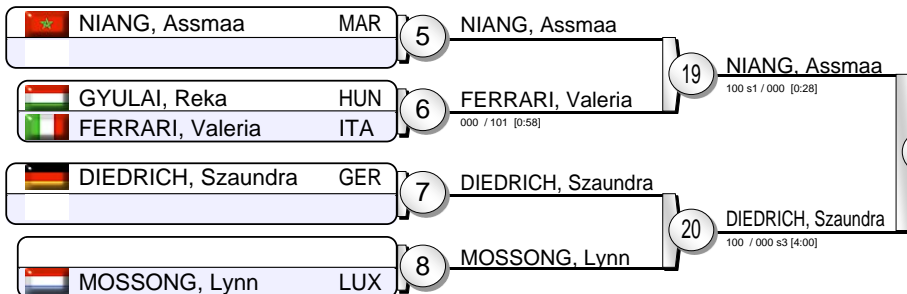

Pool C

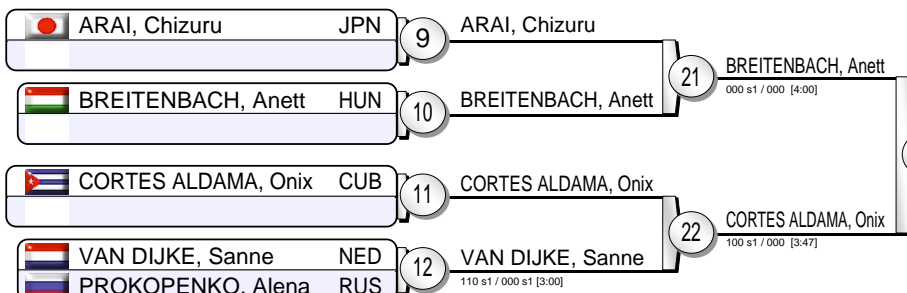

Pool D

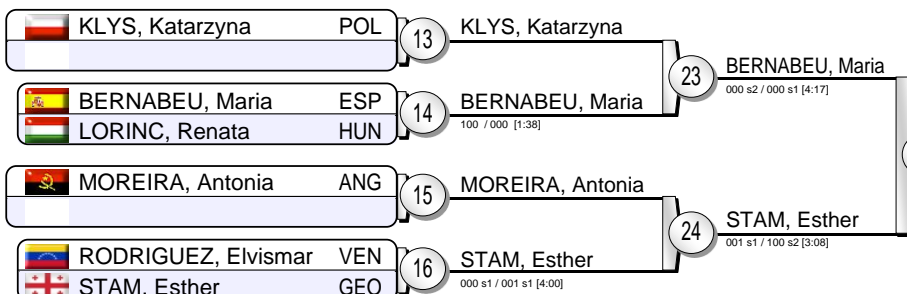

BERNABEU, Maria  
000 / 001 s1 [4:00] 35

BERNABEU, Maria  
000 / 101 [2:14] 32

Repechage

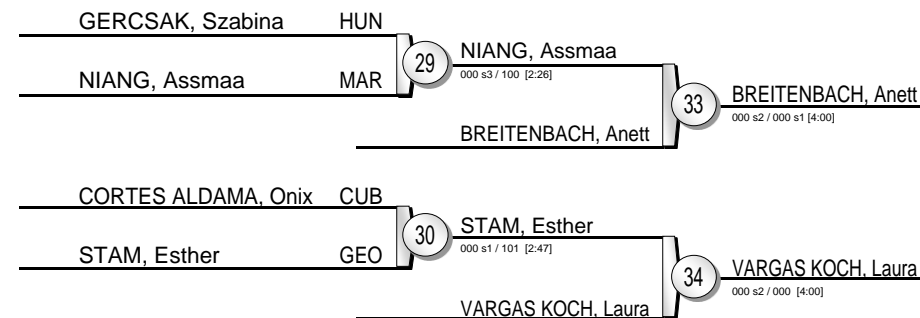

## Results

1. BERNABEU, Maria ESP
2. DIEDRICH, Szaundra GER
3. BREITENBACH, Anett HUN
3. VARGAS KOCH, Laura GER
5. NIANG, Assmaa MAR
5. STAM, Esther GEO
7. GERCSAK, Szabina HUN
7. CORTES ALDAMA, Onix CUB





# Judo Grand-Prix Budapest 2015

(HUN Budapest, 13-14 June 2015)

# -78 kg

21 Judoka

Pool A

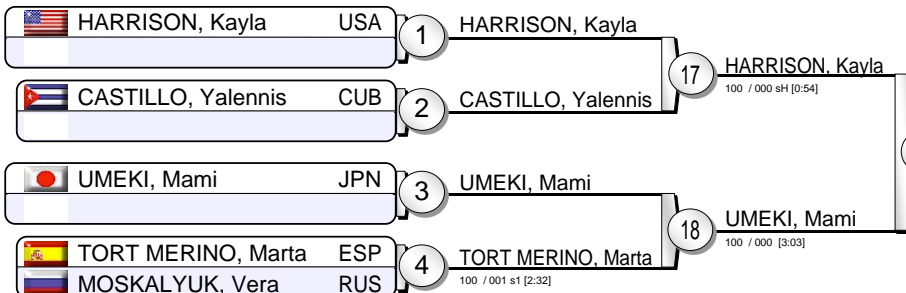

Pool B

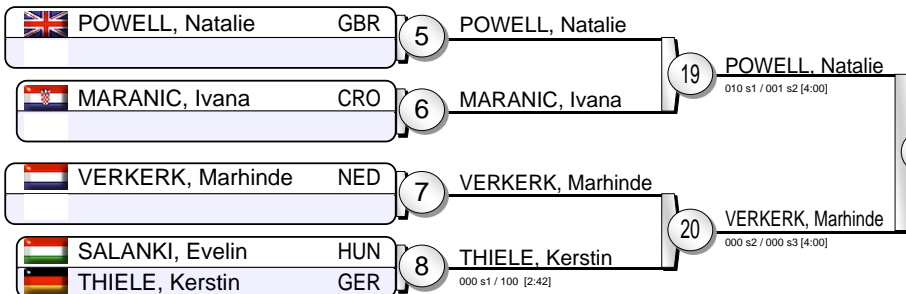

Pool C

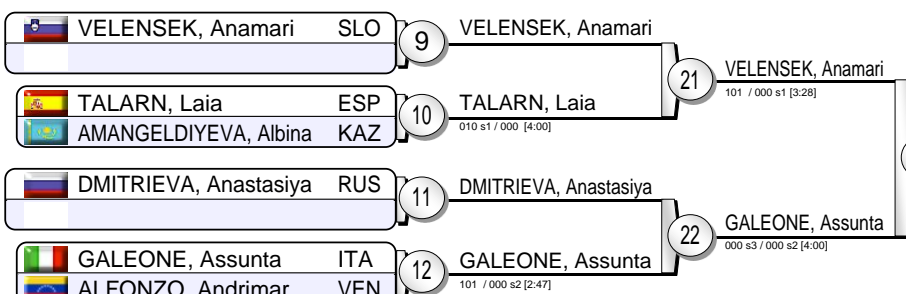

Pool D

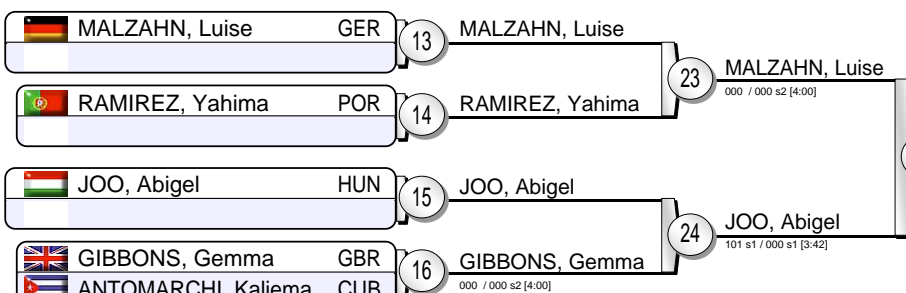

31 HARRISON, Kayla  
100 / 000 s1 [3:51]

35 HARRISON, Kayla  
113 s1 / 000 s1 [4:00]

32 VELENSEK, Anamari  
100 / 000 [2:08]

## Results

- HARRISON, Kayla USA
- VELENSEK, Anamari SLO
- MALZAHN, Luise GER
- VERKERK, Marhinde NED
- UMEKI, Mami JPN
- GALEONE, Assunta ITA
- POWELL, Natalie GBR
- JOO, Abigel HUN

Repechage

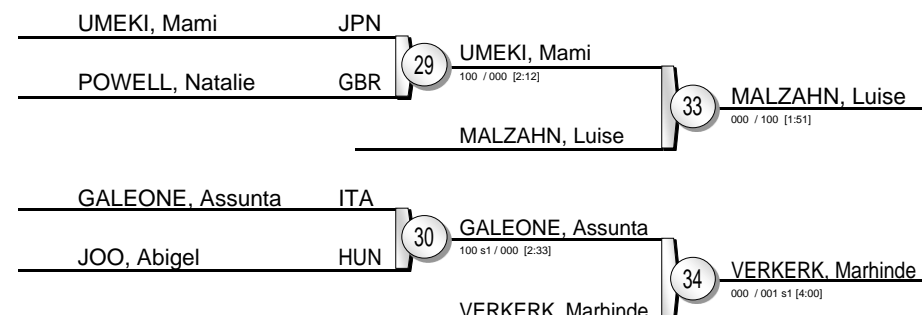



# Judo Grand-Prix Budapest 2015

(HUN Budapest, 13-14 June 2015)

# +78 kg

16 Judoka

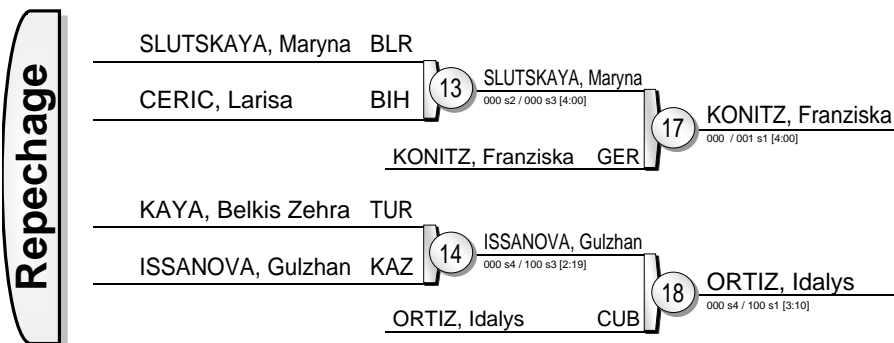

- ### Results
- |    |                      |     |
|----|----------------------|-----|
| 1. | SAYIT, Kayra         | TUR |
| 2. | CHEIKH ROUHOU, Nihel | TUN |
| 3. | KONITZ, Franziska    | GER |
| 3. | ORTIZ, Idalys        | CUB |
| 5. | SLUTSKAYA, Maryna    | BLR |
| 5. | ISSANOVA, Gulzhan    | KAZ |
| 7. | CERIC, Larisa        | BIH |
| 7. | KAYA, Belkis Zehra   | TUR |

