

LIGA - DORASTENCI
Dátum konania: 30.5.2015
Usporiadateľ: Banská Bystrica

Bodovanie	miesto:	1.	2.	3.	4.	5.
	system KO	7	5	3	-	2*
	system každý s každým	7	5	3	2	1*

Družstvo:	45 kg					50 kg					55 kg					60 kg					66 kg					Body 45-66
	1	2	3	4	5	1	2	3	4	5	1	2	3	4	5	1	2	3	4	5	1	2	3	4	5	
STU Bratislava								3					3		2,0					2		5				15
ZŤS Martin			3		0								3			7									2	15
Relax R. Sobota										2											7					9
ŠK Michalovce	7	5						3		2							5	3					3			28
Dukla B. Bystrica							5				7	5						3					3			23
ŠK Kolárovo			3																	2						5
Sokol Bratislava					0	7																			2	9

Družstvo:	73 kg					81 kg					90 kg					nad 90 kg					Body 73 - +90	Body spolu po III. kole
	1	2	3	4	5	1	2	3	4	5	1	2	3	4	5	1	2	3	4	5		
STU Bratislava	7	5					5	3		0									0		20	86+35=121 II.
ZŤS Martin					2			3		2	7			0		7		3			24	88+39=127 I.
Relax R. Sobota												5									5	47+14=61 V.
ŠK Michalovce													0				5				5	45+33=78 III.
Dukla B. Bystrica			3			7															10	38+33=71 IV.
ŠK Kolárovo			3		2																5	8+10=18 VI.
Sokol Bratislava																					0	9+9=18 VI.

*A – body získava pretekár, ktorý vyhrá min. 1 zápas s nastúpeným súperom.

*B – ak, je pretekár sám v hmotnostnej kategórii získava 3 body – kolónka za 1.miesto.

*C - za družstvo: bodujú 2 najlepší pretekári v jednej hmotnostnej kategórii a boduje maximálne 10 najlepších pretekárov.

LIGA - ŽENY**Dátum konania: 30.5.2015****Usporiadateľ: Banská Bystrica**

Bodovanie:	miesto:	1.	2.	3.	4.	5.
	system KO:	7	5	3	-	2*
	system každý s každým:	7	5	3	2	1*

Družstvo:	48 kg					52 kg					57 kg					63 kg					Body 48 – 63
	1	2	3	4	5	1	2	3	4	5	1	2	3	4	5	1	2	3	4	5	
Spartak Dubnica n/Váhom						7	5								0	7					19
STU Bratislava									0		7	5					5		2		19
Mladost' R. Sobota			0															3			3
MŠK Vranov n/Topľou	7	5						3					3,3		0					0	21

Družstvo:	nad 63 kg					Body spolu v III. kole	Body po II. kole	BODY CELKOVO
	1	2	3	4	5			
Spartak Dubnica n/Váhom						19	32	51 II.
STU Bratislava	7	5				31	50	81 I.
Mladost' R. Sobota						3	28	31 IV.
MŠK Vranov n/Topľou			3,3		0,0	27	21	48 III.

*A – body získava pretekárka, ktorá vyhrá min. 1 zápas s nastúpenou súperkou.

*B – ak, je pretekárka sama v hmotnostnej kategórii získava 3 body – kolónka za 1.miest

*C - za družstvo: bodujú 2 najlepší pretekári v jednej hmotnostnej kategórii a boduje maximálne 10 najlepších pretekárov.

Slovenský zväz JUDO

Liga dorastencov, Liga žien 3. kolo

Saturday 30 May 2015

COMPETITORS PER CLUB

Club: **Banska Bystrica Dukla**

Name	Yr of Birth	Group	Weight categor	Inscr.nr.
BANSKY, Bruno	2000	dorastenci	-50 kg	74
BARTO, Alex	2001	dorastenci	-66 kg	78
DURCO, Dalibor	1999	dorastenci	-55 kg	75
FIZEL, Marius	1999	dorastenci	-81 kg	80
LUPTAK, Jan	1999	dorastenci	-73 kg	79
POLACEK, Marek	1998	dorastenci	-60 kg	77
SRSEN, Jan	2001	dorastenci	-55 kg	76
VRBA, David	2000	dorastenci	-81 kg	81

Total number of competitors for this club 8

Club: **Bratislava STU**

Name	Yr of Birth	Group	Weight categor	Inscr.nr.
ALMASIOVA, Natalia	1997	zeny	+63 kg	32
BASALIUKOV, Vladislav	1999	dorastenci	-60 kg	44
CZIBULOVA, Karin	1992	zeny	-63 kg	34
FILO, Norbert	1999	dorastenci	-81 kg	51
GABOR, Stefan	1998	dorastenci	-73 kg	49
GADZHIEV, Dalgat	1999	dorastenci	-50 kg	40
HORACEK, Andrej	1999	dorastenci	-81 kg	52
JAKUBCOVA, Adela	1995	zeny	+63 kg	33
KANATOVA, Sofia	1997	zeny	-57 kg	36
KOZANEK, Marko	2000	dorastenci	-55 kg	39
MAJOROSOVA, Viktoria	1992	zeny	-63 kg	35
MIHALIK, Jakub	2000	dorastenci	+90 kg	50
MLYNARCIK, Matej	2000	dorastenci	-55 kg	42
MOKOS, Martin	1999	dorastenci	-66 kg	45
MUZIKOVA, Magdalena	1995	zeny	-57 kg	37
NANO, Adam	2000	dorastenci	-81 kg	46
SKORSEPOVA, Nina	1998	zeny	-52 kg	38
SMIDA, Michal	1998	dorastenci	-73 kg	48
SZABO, Milan	2000	dorastenci	-55 kg	41
TOROK, Patrik	2001	dorastenci	-55 kg	43
TURAC, Denis	2000	dorastenci	-81 kg	47

Total number of competitors for this club 21

Club: **Bratislava TJ Sokol**

Name	Yr of Birth	Group	Weight categor	Inscr.nr.
CACO, Daniel	2002	dorastenci	-50 kg	83
GASPAROVIC, Matus	2002	dorastenci	-50 kg	85
KUZEL, Otto	1999	dorastenci	-66 kg	88
SANDOR, Matej	2001	dorastenci	-73 kg	86
SZABO, Tomas	2000	dorastenci	-60 kg	87
TROJAK, Alex	2002	dorastenci	-45 kg	84
ZVARA, Adam	2002	dorastenci	-50 kg	82

Total number of competitors for this club 7

Slovenský zväz JUDO

Liga dorastencov, Liga žien 3. kolo

Saturday 30 May 2015

COMPETITORS PER CLUB

Club: **Dubnica Nad Váhom ZTS**

Name	Yr of Birth	Group	Weight categor	Inscr.nr.
KOMLOSIOVA, Ivana	1989	zeny	-63 kg	101
PRISCAKOVA, Lenka	2000	zeny	-57 kg	100
RYDZA, Barbora	1998	zeny	-52 kg	99
RYDZA, Tereza	1992	zeny	-52 kg	98

Total number of competitors for this club 4

Club: **SK Kolarovo**

Name	Yr of Birth	Group	Weight categor	Inscr.nr.
KESZELI, Robert	2002	dorastenci	-45 kg	14
KULICH, Tibor	2001	dorastenci	-55 kg	15
MITROVIC, Filip	2000	dorastenci	-73 kg	18
SZEPE, Zsolt	2000	dorastenci	-73 kg	16
TAKACS, Martin	1999	dorastenci	-60 kg	19
TAMASI, Stefan	1998	dorastenci	-66 kg	17
TYUKOS, Viktor	2000	dorastenci	-60 kg	20

Total number of competitors for this club 7

Club: **Martin Judo Club ZTS**

Name	Yr of Birth	Group	Weight categor	Inscr.nr.
HABARA, David	1999	dorastenci	-81 kg	62
HLOBEJ, Ivan	1999	dorastenci	+90 kg	57
HOFERICA, Norbert	1999	dorastenci	-73 kg	53
JADRON, Matej	1999	dorastenci	-73 kg	56
KAPRINAY, Filip	1997	dorastenci	-55 kg	58
KARASEK, Nikolas	2001	dorastenci	-66 kg	73
KOLENO, Adrian	2002	dorastenci	-55 kg	68
KOPIS, Miroslav	1998	dorastenci	-90 kg	65
KRALIK, Jan	2000	dorastenci	-55 kg	66
KRIGOVSKY, Valentin	1999	dorastenci	-81 kg	63
MARUNA, Michal	2001	dorastenci	-45 kg	72
MIKUNDA, Marko	2001	dorastenci	-66 kg	69
MJARTAN, Adam	2002	dorastenci	-60 kg	67
MORGOS, Jakub	2001	dorastenci	-55 kg	71
PODHORSKY, Martin	1998	dorastenci	-81 kg	70
RAFAJ, Jozef	2000	dorastenci	-45 kg	59
RUTTKAY, Miroslav	2000	dorastenci	-60 kg	54
SKULTETY, Denis	2001	dorastenci	-55 kg	60
SOBKULIAK, Rastislav	1998	dorastenci	-90 kg	55
STROMKO, Lubomir	2000	dorastenci	+90 kg	64
VOLKOV, Peter	1999	dorastenci	-66 kg	61

Total number of competitors for this club 21

Club: **Michalovce SK Zemplin**

Name	Yr of Birth	Group	Weight categor	Inscr.nr.
JACKANIN, Patrik	2002	dorastenci	-45 kg	11
JENISCH, Filip	1999	dorastenci	-66 kg	7

Slovenský zväz JUDO

Liga dorastencov, Liga žien 3. kolo

Saturday 30 May 2015

COMPETITORS PER CLUB

KOREN, Stefan	2002	dorastenci	-50 kg	2
KRIZAK, Marian	1998	dorastenci	+90 kg	9
LACH, Jakub	2000	dorastenci	-90 kg	13
MLYNARIC, Daniel	2000	dorastenci	-60 kg	10
PAKAN, Matej	2000	dorastenci	-55 kg	3
POPOVIC, Marcus	2001	dorastenci	-60 kg	5
ROSKO, Martin	2000	dorastenci	-60 kg	6
RUJAK, Milan	1999	dorastenci	-66 kg	4
VAN DER VALK, Dirk	1999	dorastenci	-73 kg	8
VANEK, Miroslav	2002	dorastenci	-50 kg	12
WITKOVSKI, Bartolomej	2001	dorastenci	-45 kg	1

Total number of competitors for this club 13

Club: **Rimavska Sobota TJ Mladost RELAX**

Name	Yr of Birth	Group	Weight categor	Inscr.nr.
ANTAL, Juraj	1998	dorastenci	-66 kg	92
BORSOS, Patrik	1998	dorastenci	-66 kg	93
HALAJ, Matej	1999	dorastenci	-55 kg	90
HANULA, Patrik	2000	dorastenci	-55 kg	89
HLOUSEK, Samuel	2001	dorastenci	-50 kg	91
KURAK, Lukas	1998	dorastenci	-90 kg	94
MULLEROVA, Nikoleta	2000	zeny	-48 kg	95
OCENASOVA, Zuzana	1998	zeny	-63 kg	96
SVORENOVA, Beata	1977	zeny	-57 kg	97

Total number of competitors for this club 9

Club: **Vranov Nad Toplou MSK**

Name	Yr of Birth	Group	Weight categor	Inscr.nr.
ARENDACOVA, Zuzana	1997	zeny	-57 kg	27
GALLSCHNEIDEROVA, Natali	1998	zeny	-57 kg	31
HALASOVA, Katarina	1995	zeny	+63 kg	28
HLADOVA, Michaela	1996	zeny	-52 kg	22
KINCELOVA, Dominika	1998	zeny	-48 kg	29
KORENOVA, Eva	1999	zeny	+63 kg	25
MIKOVA, Viktoria	2015	zeny	-57 kg	23
MORONGOVA, Miroslava	2000	zeny	-48 kg	21
PETRUNY, Natalia	1999	zeny	+63 kg	26
VARADYOVA, Martina	1998	zeny	+63 kg	24
VAVREKOVA, Daniela	1998	zeny	-63 kg	30

Total number of competitors for this club 11

Slovenský zväz JUDO

Liga dorastencov, Liga žien 3. kolo

Saturday 30 May 2015

NR OF COMPETITORS PER CLUB

DuBB	Banska Bystrica Dukla,	8	cr.nr	0,00
SUBa	Bratislava STU,	21	cr.nr	0,00
SoBA	Bratislava TJ Sokol,	7	cr.nr	0,00
DnV	Dubnica Nad Váhom ZTS,	4	cr.nr	0,00
Kol	Kolarovo, SK	7	cr.nr	0,00
JcMT	Martin Judo Club ZTS,	21	cr.nr	0,00
SKMI	Michalovce SK Zemplin,	13	cr.nr	0,00
MLRS	Rimavska Sobota TJ Mladost RELAX,	9	cr.nr	0,00
VnT	Vranov Nad Toplou MSK,	11	cr.nr	0,00
				<hr/>
	Short	101	scr.nr	0,00

Slovenský zväz JUDO

Liga dorastencov, Liga žien 3. kolo

Saturday 30 May 2015

COMPETITORS PER WEIGHT CATEGORY

WEIGHT CATEGORY: dorastenci, -45 kg

Name	Inscr.nr	Y.Of.B.	Club:	Country
JACKANIN, Patrik	11	2002	Michalovce SK Zemplin	Slovak Republic
KESZELI, Robert	14	2002	SKKolarovo	Slovak Republic
MARUNA, Michal	72	2001	Martin Judo Club ZTS	Slovak Republic
RAFAJ, Jozef	59	2000	Martin Judo Club ZTS	Slovak Republic
TROJAK, Alex	84	2002	Bratislava TJ Sokol	Slovak Republic
WITKOVSKI, Bartolomej	1	2001	Michalovce SK Zemplin	Slovak Republic

Total in this weight category: 6

WEIGHT CATEGORY: dorastenci, -50 kg

Name	Inscr.nr	Y.Of.B.	Club:	Country
BANSKY, Bruno	74	2000	Banska Bystrica Dukla	Slovak Republic
CACO, Daniel	83	2002	Bratislava TJ Sokol	Slovak Republic
GADZHIEV, Dalgat	40	1999	Bratislava STU	Slovak Republic
GASPAROVIC, Matus	85	2002	Bratislava TJ Sokol	Slovak Republic
HLOUSEK, Samuel	91	2001	Rimavska Sobota TJ Mladost RELA	Slovak Republic
KOREN, Stefan	2	2002	Michalovce SK Zemplin	Slovak Republic
VANEK, Miroslav	12	2002	Michalovce SK Zemplin	Slovak Republic
ZVARA, Adam	82	2002	Bratislava TJ Sokol	Slovak Republic

Total in this weight category: 8

WEIGHT CATEGORY: dorastenci, -55 kg

Name	Inscr.nr	Y.Of.B.	Club:	Country
DURCO, Dalibor	75	1999	Banska Bystrica Dukla	Slovak Republic
HALAJ, Matej	90	1999	Rimavska Sobota TJ Mladost RELA	Slovak Republic
HANULA, Patrik	89	2000	Rimavska Sobota TJ Mladost RELA	Slovak Republic
KAPRINAY, Filip	58	1997	Martin Judo Club ZTS	Slovak Republic
KOLENO, Adrian	68	2002	Martin Judo Club ZTS	Slovak Republic
KOZANEK, Marko	39	2000	Bratislava STU	Slovak Republic
KRALIK, Jan	66	2000	Martin Judo Club ZTS	Slovak Republic
KULICH, Tibor	15	2001	SKKolarovo	Slovak Republic
MLYNARCIK, Matej	42	2000	Bratislava STU	Slovak Republic
MORGOS, Jakub	71	2001	Martin Judo Club ZTS	Slovak Republic
PAKAN, Matej	3	2000	Michalovce SK Zemplin	Slovak Republic
SKULTETY, Denis	60	2001	Martin Judo Club ZTS	Slovak Republic
SRSEN, Jan	76	2001	Banska Bystrica Dukla	Slovak Republic
SZABO, Milan	41	2000	Bratislava STU	Slovak Republic
TOROK, Patrik	43	2001	Bratislava STU	Slovak Republic

Total in this weight category: 15

WEIGHT CATEGORY: dorastenci, -60 kg

Name	Inscr.nr	Y.Of.B.	Club:	Country
BASALIUKOV, Vladislav	44	1999	Bratislava STU	Slovak Republic
MJARTAN, Adam	67	2002	Martin Judo Club ZTS	Slovak Republic
MLYNARIC, Daniel	10	2000	Michalovce SK Zemplin	Slovak Republic
POLACEK, Marek	77	1998	Banska Bystrica Dukla	Slovak Republic
POPOVIC, Marcus	5	2001	Michalovce SK Zemplin	Slovak Republic
ROSHKO, Martin	6	2000	Michalovce SK Zemplin	Slovak Republic
RUTTKAY, Miroslav	54	2000	Martin Judo Club ZTS	Slovak Republic
SZABO, Tomas	87	2000	Bratislava TJ Sokol	Slovak Republic
TAKACS, Martin	19	1999	SKKolarovo	Slovak Republic

Slovenský zväz JUDO

Liga dorastencov, Liga žien 3. kolo

Saturday 30 May 2015

COMPETITORS PER WEIGHT CATEGORY

TYUKOS, Viktor	20	2000	SKKolarovo	Slovak Republic
----------------	----	------	------------	-----------------

Total in this weight category: 10

WEIGHT CATEGORY: dorastenci, -66 kg

Name	Inscr.nr	Y.Of.B.	Club:	Country
ANTAL, Juraj	92	1998	Rimavska Sobota TJ Mladost RELA	Slovak Republic
BARTO, Alex	78	2001	Banska Bystrica Dukla	Slovak Republic
BORSOS, Patrik	93	1998	Rimavska Sobota TJ Mladost RELA	Slovak Republic
JENISCH, Filip	7	1999	Michalovce SK Zemplin	Slovak Republic
KARASEK, Nikolas	73	2001	Martin Judo Club ZTS	Slovak Republic
KUZEL, Otto	88	1999	Bratislava TJ Sokol	Slovak Republic
MIKUNDA, Marko	69	2001	Martin Judo Club ZTS	Slovak Republic
MOKOS, Martin	45	1999	Bratislava STU	Slovak Republic
RUJAK, Milan	4	1999	Michalovce SK Zemplin	Slovak Republic
TAMASI, Stefan	17	1998	SKKolarovo	Slovak Republic
VOLKOV, Peter	61	1999	Martin Judo Club ZTS	Slovak Republic

Total in this weight category: 11

WEIGHT CATEGORY: dorastenci, -73 kg

Name	Inscr.nr	Y.Of.B.	Club:	Country
GABOR, Stefan	49	1998	Bratislava STU	Slovak Republic
HOFERICA, Norbert	53	1999	Martin Judo Club ZTS	Slovak Republic
JADRON, Matej	56	1999	Martin Judo Club ZTS	Slovak Republic
LUPTAK, Jan	79	1999	Banska Bystrica Dukla	Slovak Republic
MITROVIC, Filip	18	2000	SKKolarovo	Slovak Republic
SANDOR, Matej	86	2001	Bratislava TJ Sokol	Slovak Republic
SMIDA, Michal	48	1998	Bratislava STU	Slovak Republic
SZEPE, Zsolt	16	2000	SKKolarovo	Slovak Republic
VALK, Dirk van der	8	1999	Michalovce SK Zemplin	Slovak Republic

Total in this weight category: 9

WEIGHT CATEGORY: dorastenci, -81 kg

Name	Inscr.nr	Y.Of.B.	Club:	Country
FILO, Norbert	51	1999	Bratislava STU	Slovak Republic
FIZEL, Marius	80	1999	Banska Bystrica Dukla	Slovak Republic
HABARA, David	62	1999	Martin Judo Club ZTS	Slovak Republic
HORACEK, Andrej	52	1999	Bratislava STU	Slovak Republic
KRIGOVSKY, Valentin	63	1999	Martin Judo Club ZTS	Slovak Republic
NANO, Adam	46	2000	Bratislava STU	Slovak Republic
PODHORSKY, Martin	70	1998	Martin Judo Club ZTS	Slovak Republic
TURAC, Denis	47	2000	Bratislava STU	Slovak Republic
VRBA, David	81	2000	Banska Bystrica Dukla	Slovak Republic

Total in this weight category: 9

WEIGHT CATEGORY: dorastenci, -90 kg

Name	Inscr.nr	Y.Of.B.	Club:	Country
KOPIS, Miroslav	65	1998	Martin Judo Club ZTS	Slovak Republic
KURAK, Lukas	94	1998	Rimavska Sobota TJ Mladost RELA	Slovak Republic
LACH, Jakub	13	2000	Michalovce SK Zemplin	Slovak Republic
SOBKULIAK, Rastislav	55	1998	Martin Judo Club ZTS	Slovak Republic

Total in this weight category: 4

Slovenský zväz JUDO

Liga dorastencov, Liga žien 3. kolo

Saturday 30 May 2015

COMPETITORS PER WEIGHT CATEGORY

WEIGHT CATEGORY: dorastenci, +90 kg

Name	Inscr.nr	Y.Of.B.	Club:	Country
HLOBEJ, Ivan	57	1999	Martin Judo Club ZTS	Slovak Republic
KRIZAK, Marian	9	1998	Michalovce SK Zemplin	Slovak Republic
MIHALIK, Jakub	50	2000	Bratislava STU	Slovak Republic
STROMKO, Lubomir	64	2000	Martin Judo Club ZTS	Slovak Republic

Total in this weight category: 4

WEIGHT CATEGORY: zeny, -48 kg

Name	Inscr.nr	Y.Of.B.	Club:	Country
KINCELOVA, Dominika	29	1998	Vranov Nad Toplou MSK	Slovak Republic
MORONGOVA, Miroslava	21	2000	Vranov Nad Toplou MSK	Slovak Republic
MULLEROVA, Nikoleta	95	2000	Rimavska Sobota TJ Mladost RELA	Slovak Republic

Total in this weight category: 3

WEIGHT CATEGORY: zeny, -52 kg

Name	Inscr.nr	Y.Of.B.	Club:	Country
HLADOVA, Michaela	22	1996	Vranov Nad Toplou MSK	Slovak Republic
RYDZA, Barbora	99	1998	Dubnica Nad Váhom ZTS	Slovak Republic
RYDZA, Tereza	98	1992	Dubnica Nad Váhom ZTS	Slovak Republic
SKORSEPOVA, Nina	38	1998	Bratislava STU	Slovak Republic

Total in this weight category: 4

WEIGHT CATEGORY: zeny, -57 kg

Name	Inscr.nr	Y.Of.B.	Club:	Country
ARENDACOVA, Zuzana	27	1997	Vranov Nad Toplou MSK	Slovak Republic
GALLSCHNEIDEROVA, Natalia	31	1998	Vranov Nad Toplou MSK	Slovak Republic
KANATOVA, Sofia	36	1997	Bratislava STU	Slovak Republic
MIKOVA, Viktoria	23	2015	Vranov Nad Toplou MSK	Slovak Republic
MUZIKOVA, Magdalena	37	1995	Bratislava STU	Slovak Republic
PRISCAKOVA, Lenka	100	2000	Dubnica Nad Váhom ZTS	Slovak Republic
SVORENOVA, Beata	97	1977	Rimavska Sobota TJ Mladost RELA	Slovak Republic

Total in this weight category: 7

WEIGHT CATEGORY: zeny, -63 kg

Name	Inscr.nr	Y.Of.B.	Club:	Country
CZIBULOVA, Karin	34	1992	Bratislava STU	Slovak Republic
KOMLOSIOVA, Ivana	101	1989	Dubnica Nad Váhom ZTS	Slovak Republic
MAJOROSOVA, Viktoria	35	1992	Bratislava STU	Slovak Republic
OCENASOVA, Zuzana	96	1998	Rimavska Sobota TJ Mladost RELA	Slovak Republic
VAVREKOVA, Daniela	30	1998	Vranov Nad Toplou MSK	Slovak Republic

Total in this weight category: 5

WEIGHT CATEGORY: zeny, +63 kg

Name	Inscr.nr	Y.Of.B.	Club:	Country
ALMASIOVA, Natalia	32	1997	Bratislava STU	Slovak Republic
HALASOVA, Katarina	28	1995	Vranov Nad Toplou MSK	Slovak Republic
JAKUBCOVA, Adela	33	1995	Bratislava STU	Slovak Republic
KORENOVA, Eva	25	1999	Vranov Nad Toplou MSK	Slovak Republic
PETRUNY, Natalia	26	1999	Vranov Nad Toplou MSK	Slovak Republic
VARADYOVA, Martina	24	1998	Vranov Nad Toplou MSK	Slovak Republic

Slovenský zväz JUDO

Liga dorastencov, Liga žien 3. kolo

Saturday 30 May 2015

COMPETITORS PER WEIGHT CATEGORY

Total in this weight category: 6

Slovenský zväz JUDO

Liga dorastencov, Liga žien 3. kolo

MEDAL WINNERS

	<u>dorastenci</u>	<u>dorastenci</u>
-45 kg	1 WITKOVSKI, Bartolomej Michalovce SK Zemplin 2 JACKANIN, Patrik Michalovce SK Zemplin 3 MARUNA, Michal Martin Judo Club ZTS 3 KESZELI, Robert Kolarovo 5 RAFAJ, Jozef Martin Judo Club ZTS 5 TROJAK, Alex Bratislava TJ Sokol	1 GASPAROVIC, Matus Bratislava TJ Sokol 2 BANSKY, Bruno Banska Bystrica Dukla 3 KOREN, Stefan Michalovce SK Zemplin 3 GADZHIEV, Dalgat Bratislava STU 5 HLOUSEK, Samuel Rimavska Sobota TJ M 5 VANEK, Miroslav Michalovce SK Zemplin
-55 kg	1 DURCO, Dalibor Banska Bystrica Dukla 2 SRSEN, Jan Banska Bystrica Dukla 3 KAPRINAY, Filip Martin Judo Club ZTS 3 TOROK, Patrik Bratislava STU 5 KOZANEK, Marko Bratislava STU 5 MLYNARCIK, Matej Bratislava STU	1 RUTTKAY, Miroslav Martin Judo Club ZTS 2 MLYNARIC, Daniel Michalovce SK Zemplin 3 ROSHKO, Martin Michalovce SK Zemplin 3 POLACEK, Marek Banska Bystrica Dukla 5 TYUKOS, Viktor Kolarovo 5 BASALIUKOV, Vladislav Bratislava STU
-66 kg	1 BORSOS, Patrik Rimavska Sobota TJ Mla 2 MOKOS, Martin Bratislava STU 3 RUJAK, Milan Michalovce SK Zemplin 3 BARTO, Alex Banska Bystrica Dukla 5 KARASEK, Nikolas Martin Judo Club ZTS 5 KUZEL, Otto Bratislava TJ Sokol	1 SMIDA, Michal Bratislava STU 2 GABOR, Stefan Bratislava STU 3 SZEPE, Zsolt Kolarovo 3 LUPTAK, Jan Banska Bystrica Dukla 5 JADRON, Matej Martin Judo Club ZTS 5 MITROVIC, Filip Kolarovo
-81 kg	1 FIZEL, Marius Banska Bystrica Dukla 2 TURAC, Denis Bratislava STU 3 HORACEK, Andrej Bratislava STU 3 KRIGOVSKY, Valentin Martin Judo Club ZTS 5 PODHORSKY, Martin Martin Judo Club ZTS 5 NANO, Adam Bratislava STU	1 KOPIS, Miroslav Martin Judo Club ZTS 2 KURAK, Lukas Rimavska Sobota TJ M 3 LACH, Jakub Michalovce SK Zemplin 4 SOBKULIAK, Rastislav Martin Judo Club ZTS
+90 kg	1 HLOBEJ, Ivan Martin Judo Club ZTS 2 KRIZAK, Marian Michalovce SK Zemplin 3 STROMKO, Lubomir Martin Judo Club ZTS 4 MIHALIK, Jakub Bratislava STU 5 5	

Slovenský zväz JUDO

Liga dorastencov, Liga žien 3. kolo

MEDAL WINNERS

	<u>zeny</u>	
-48 kg	1	KINCELOVA, Dominika Vranov Nad Toplou MSK
	2	MORONGOVA, Miroslava Vranov Nad Toplou MSK
	3	MULLEROVA, Nikoleta Rimavska Sobota TJ Mla
	3	
	5	
-57 kg	1	MUZIKOVA, Magdalena Bratislava STU
	2	KANATOVA, Sofia Bratislava STU
	3	ARENDACOVA, Zuzana Vranov Nad Toplou MSK
	3	MIKOVA, Viktoria Vranov Nad Toplou MSK
	5	GALLSCHNEIDEROVA, I Vranov Nad Toplou MSK
5	PRISCAKOVA, Lenka Dubnica Nad Váhom ZTS	
+63 kg	1	JAKUBCOVA, Adela Bratislava STU
	2	ALMASIOVA, Natalia Bratislava STU
	3	VARADYOVA, Martina Vranov Nad Toplou MSK
	3	KORENOVA, Eva Vranov Nad Toplou MSK
	5	PETRUNY, Natalia Vranov Nad Toplou MSK
5	HALASOVA, Katarina Vranov Nad Toplou MSK	

	<u>zeny</u>	
-52 kg	1	RYDZA, Tereza Dubnica Nad Váhom Z
	2	RYDZA, Barbora Dubnica Nad Váhom Z
	3	HLADOVA, Michaela Vranov Nad Toplou M
	4	SKORSEPOVA, Nina Bratislava STU
-63 kg	1	KOMLOSIOVA, Ivana Dubnica Nad Váhom Z
	2	MAJOROSOVA, Viktoria Bratislava STU
	3	OCENASOVA, Zuzana Rimavska Sobota TJ M
	4	CZIBULOVA, Karin Bratislava STU
	5	VAVREKOVA, Daniela Vranov Nad Toplou M

Slovenský zväz JUDO

Liga dorastencov, Liga žien 3. kolo

MEDALS PER CLUB PER GROUP

dorastenci	Gold	Silver	Bronze	4	5	7
1 Martin Judo Club ZTS	3		4	1	4	4
2 Banska Bystrica Dukla	2	2	3			
3 Michalovce SK Zemplin	1	3	4		1	1
4 Bratislava STU	1	3	3	1	4	1
5 Rimavska Sobota TJ Mladost RELAX	1	1			1	1
6 Bratislava TJ Sokol	1				2	4
7 Kolarovo, SK			2		2	1

Slovenský zväz JUDO

Liga dorastencov, Liga žien 3. kolo

MEDALS PER CLUB PER GROUP

<u>zeny</u>	Gold	Silver	Bronze	4	5	7
1 Bratislava STU	2	3		2		
2 Dubnica Nad Váhom ZTS	2	1			1	
3 Vranov Nad Toplou MSK	1	1	5		4	
4 Rimavska Sobota TJ Mladost RELAX			2			1

Slovenský zväz JUDO

Liga dorastencov, Liga žien 3. kolo

Weight category: dorastenci -45 kg

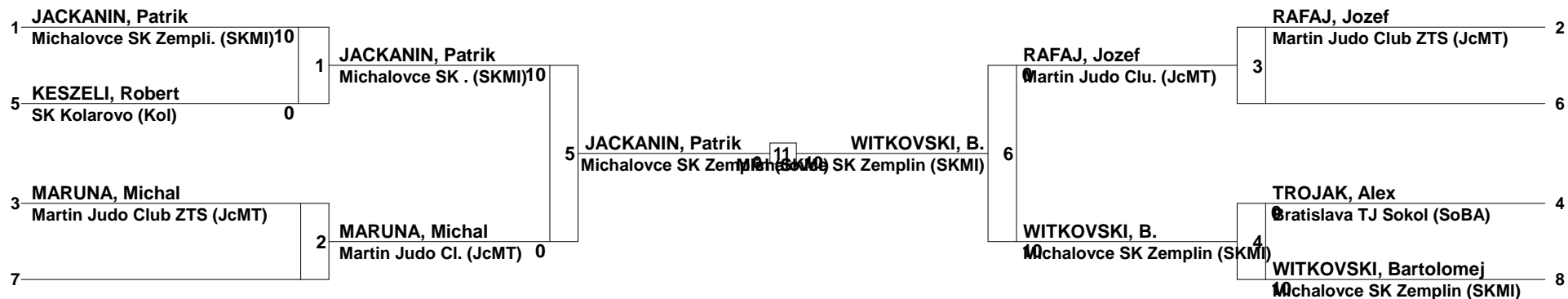

1 ^e	WITKOVSKI, Bartolomej	SKMI
2 ^e	JACKANIN, Patrik	SKMI
3 ^e	KESZELI, Robert	Kol
3 ^e	MARUNA, Michal	JcMT

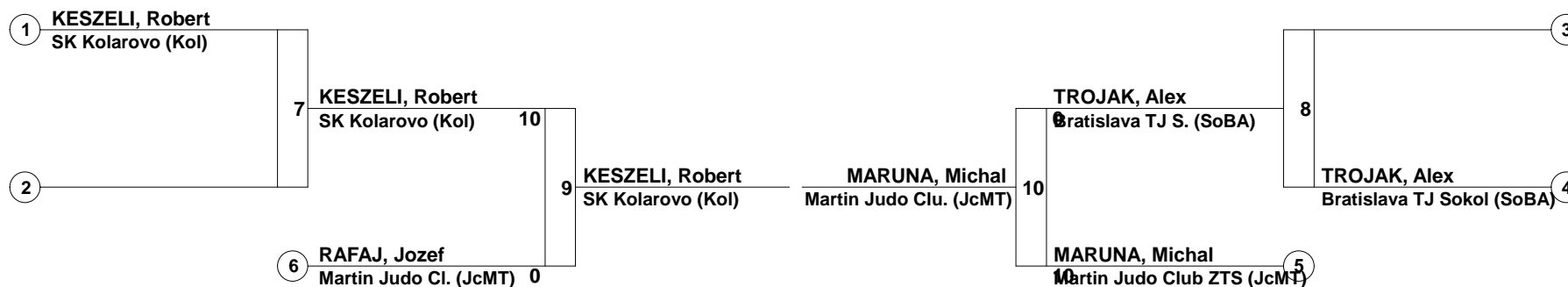

Slovenský zväz JUDO

Liga dorastencov, Liga žien 3. kolo

Weight category: dorastenci -50 kg



1 ^e	GASPAROVIC, Matus	SoBA
2 ^e	BANSKY, Bruno	DuBB
3 ^e	GADZHIEV, Dalgat	SUBa
3 ^e	KOREN, Stefan	SKMI

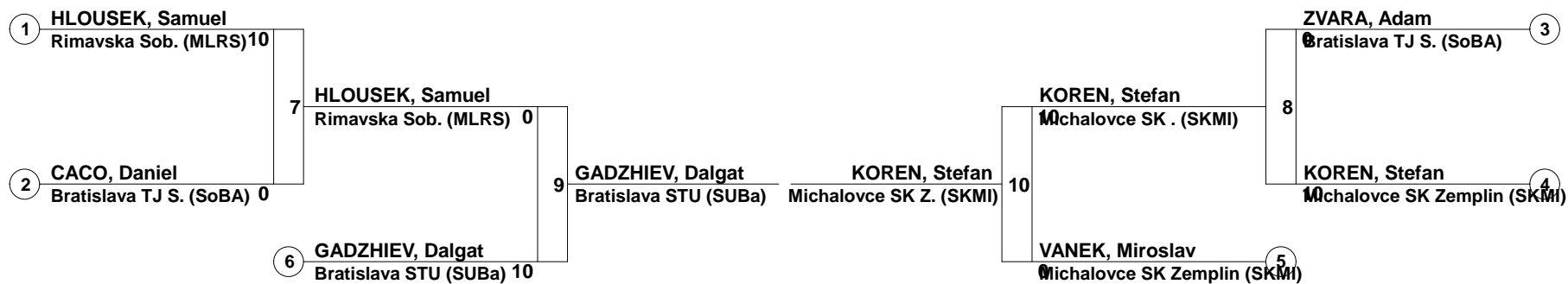

Slovenský zväz JUDO

Liga dorastencov, Liga žien 3. kolo

Weight category: dorastenci -55 kg

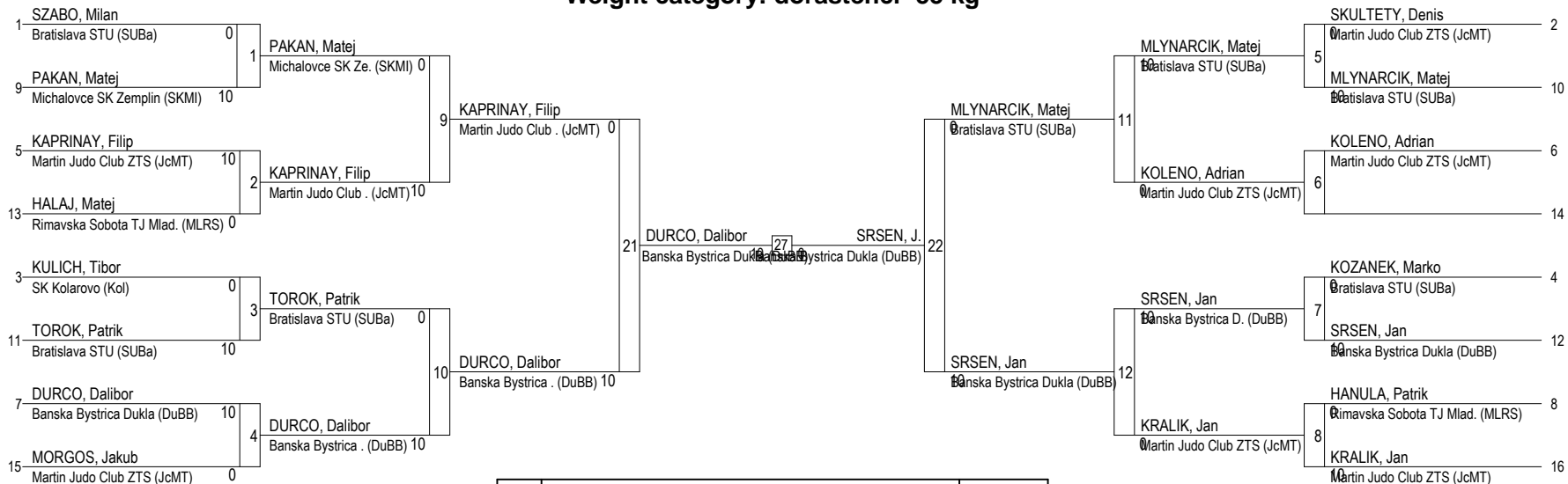

1^e	DURCO, Dalibor	DuBB
2^e	SRSEN, Jan	DuBB
3^e	TOROK, Patrik	SUBa
3^e	KAPRINAY, Filip	JcMT

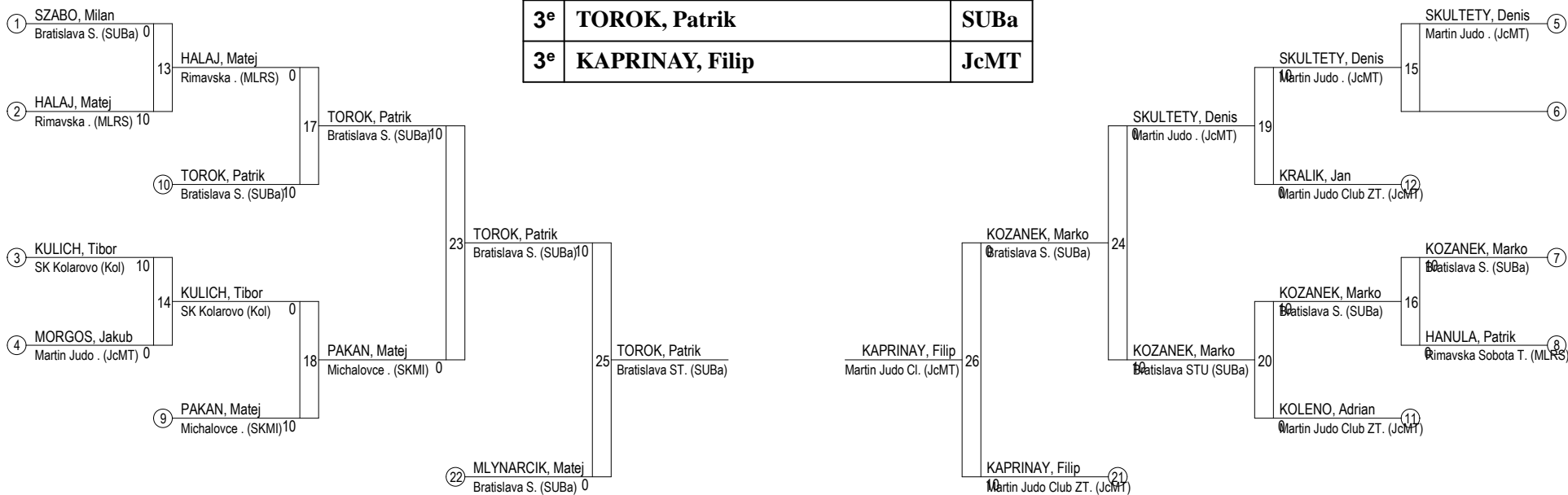

Slovenský zväz JUDO

Liga dorastencov, Liga žien 3. kolo

Weight category: dorastenci -60 kg

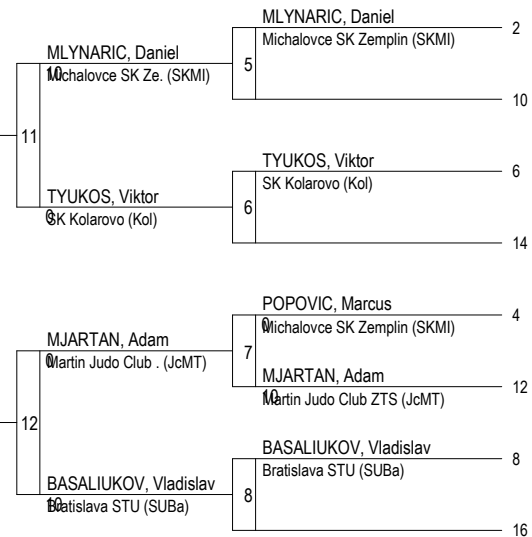
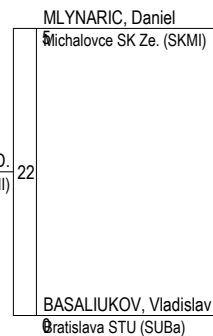
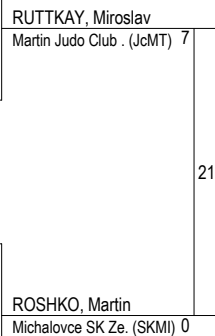
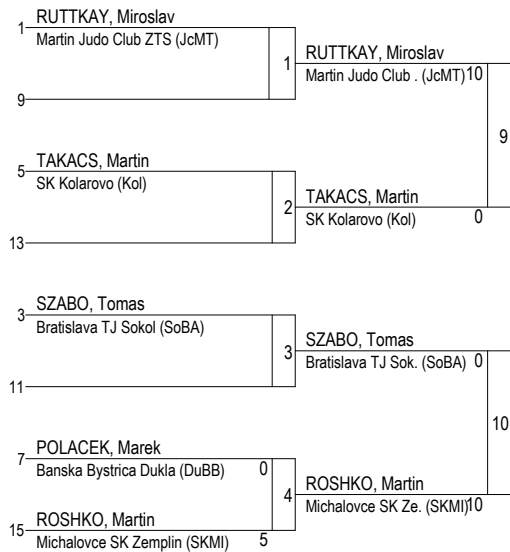

1^e	RUTTKAY, Miroslav	JcMT
2^e	MLYNARIC, Daniel	SKMI
3^e	POLACEK, Marek	DuBB
3^e	ROSHKO, Martin	SKMI

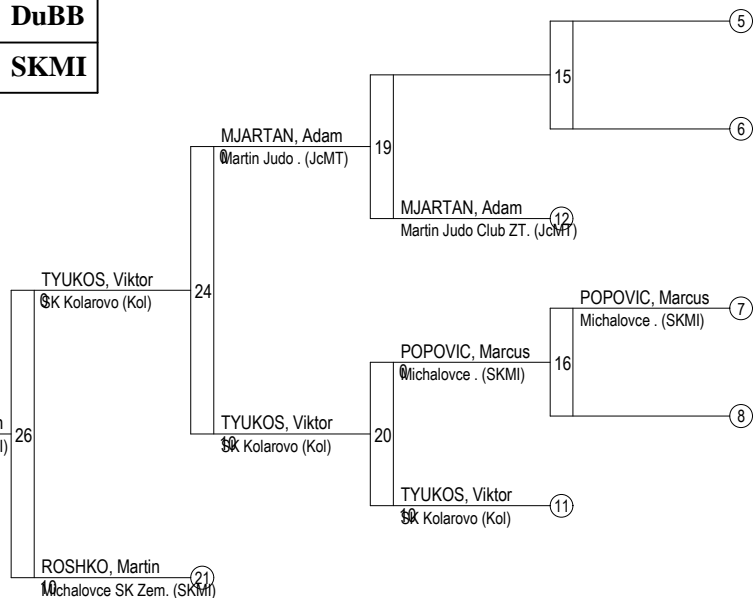
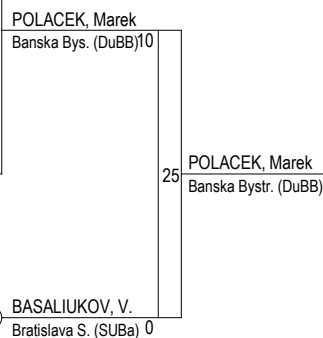
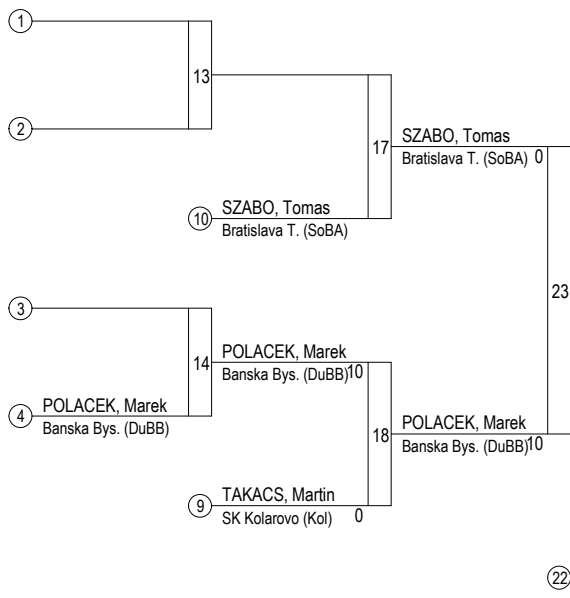

Slovenský zväz JUDO

Liga dorastencov, Liga žien 3. kolo

Weight category: dorastenci -66 kg

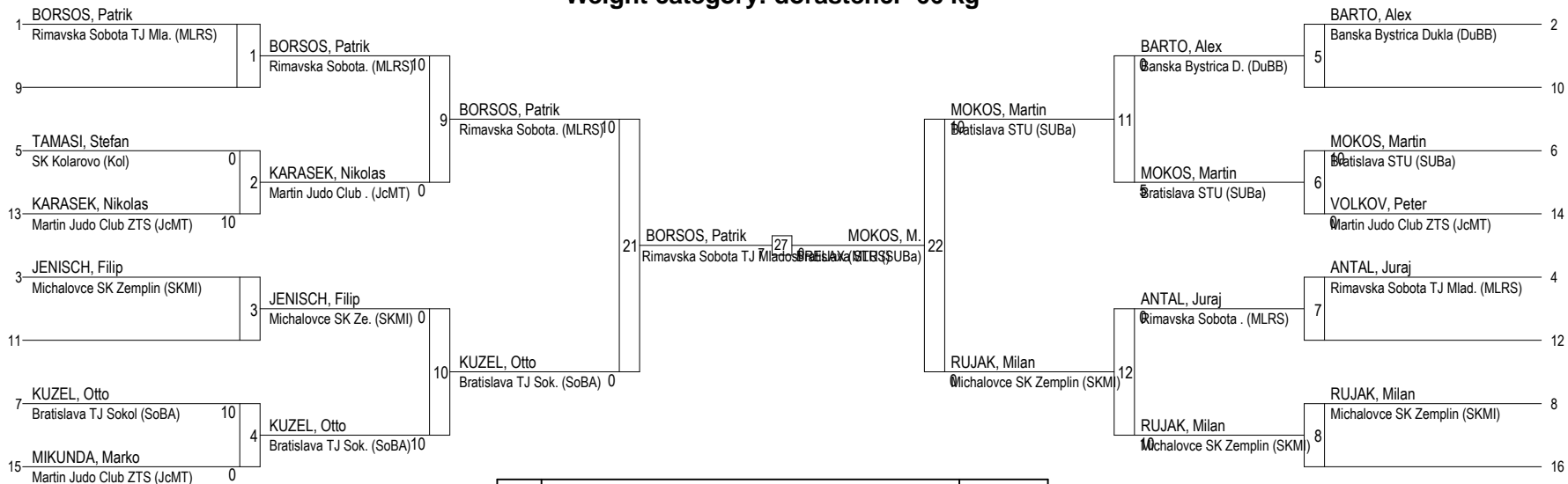

1^e	BORSOS, Patrik	MLRS
2^e	MOKOS, Martin	SUBa
3^e	RUJAK, Milan	SKMI
3^e	BARTO, Alex	DuBB

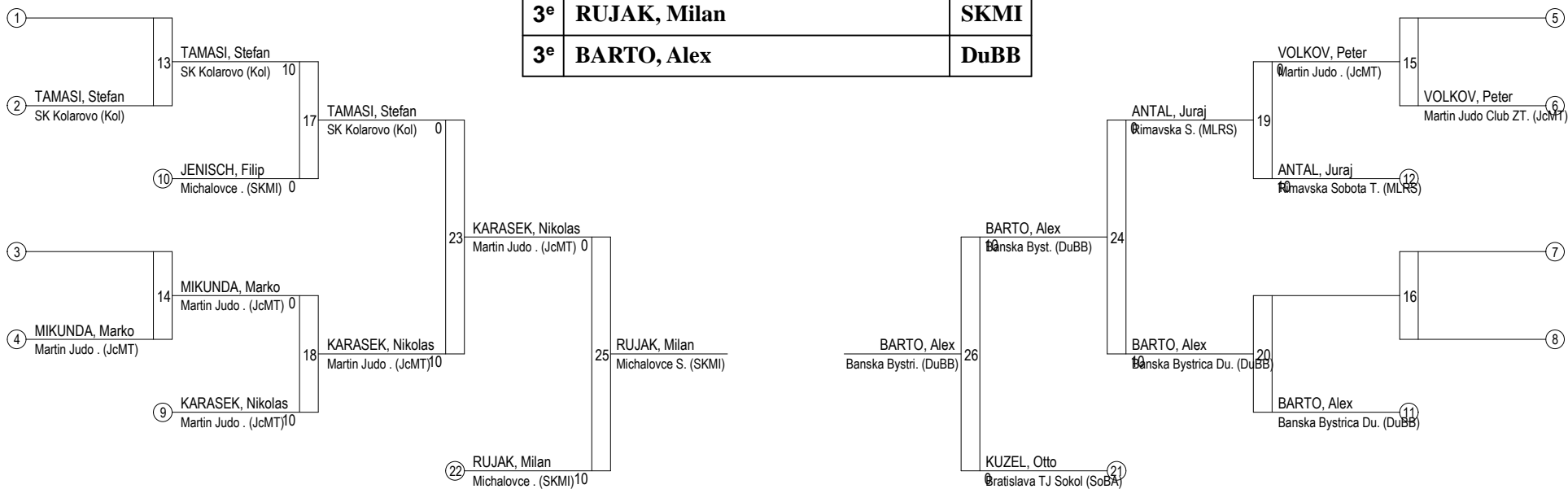

Slovenský zväz JUDO

Liga dorastencov, Liga žien 3. kolo

Weight category: dorastenci -73 kg

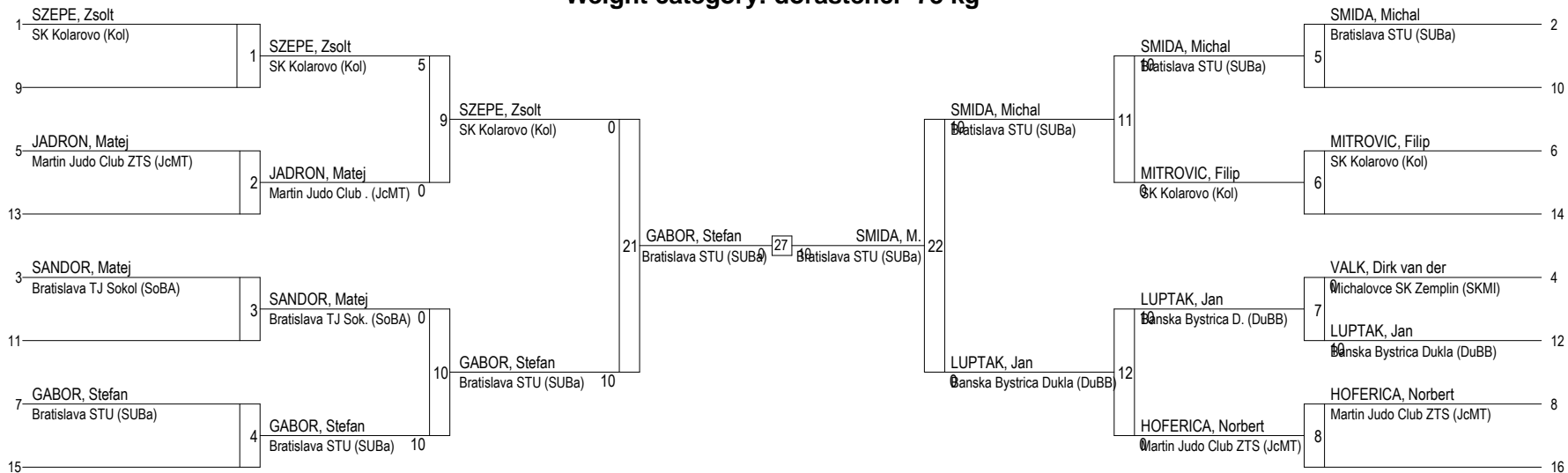

1^e	SMIDA, Michal	SUBa
2^e	GABOR, Stefan	SUBa
3^e	LUPTAK, Jan	DuBB
3^e	SZEPE, Zsolt	Kol

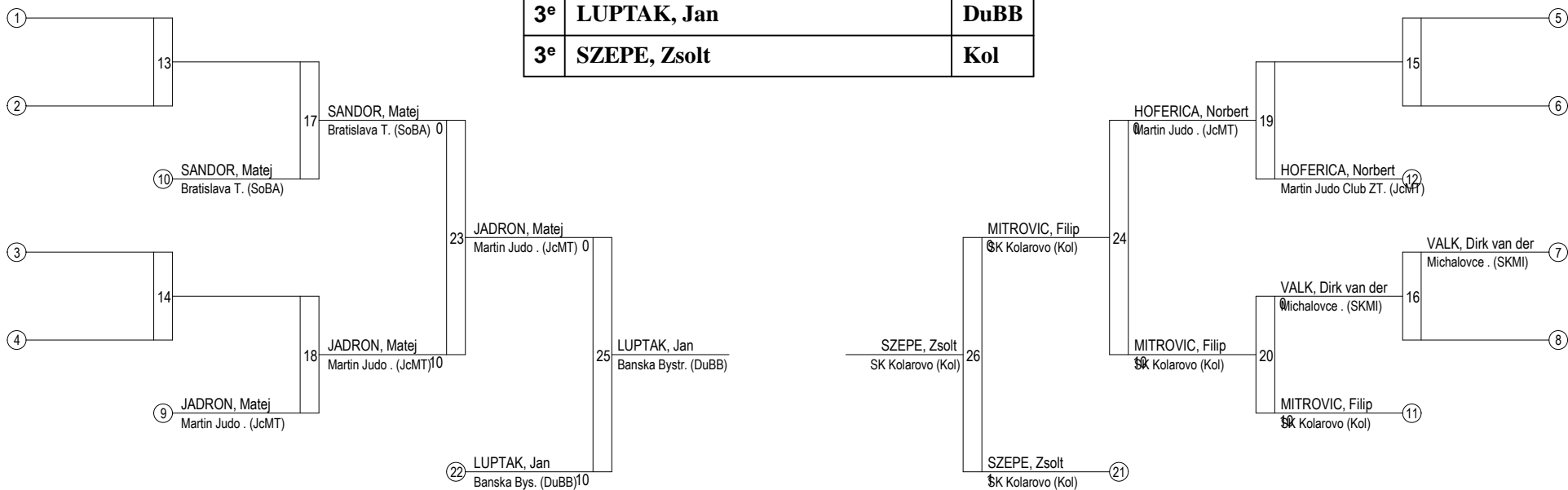

Slovenský zväz JUDO

Liga dorastencov, Liga žien 3. kolo

Weight category: dorastenci -81 kg

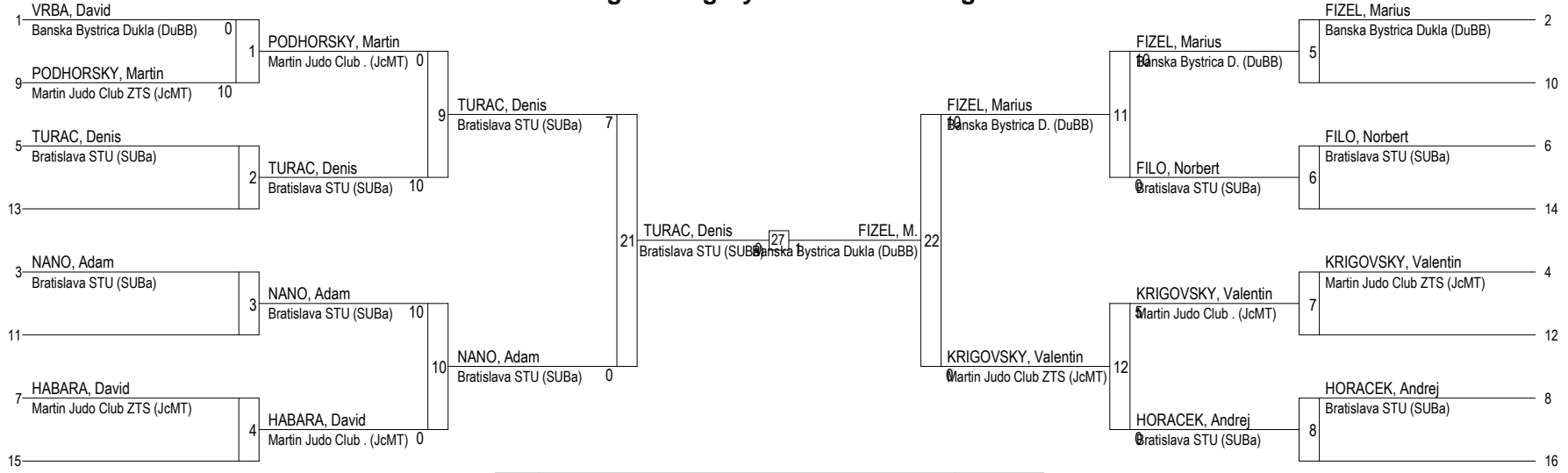

1^e	FIZEL, Marius	DuBB
2^e	TURAC, Denis	SUBa
3^e	KRIGOVSKY, Valentin	JcMT
3^e	HORACEK, Andrej	SUBa

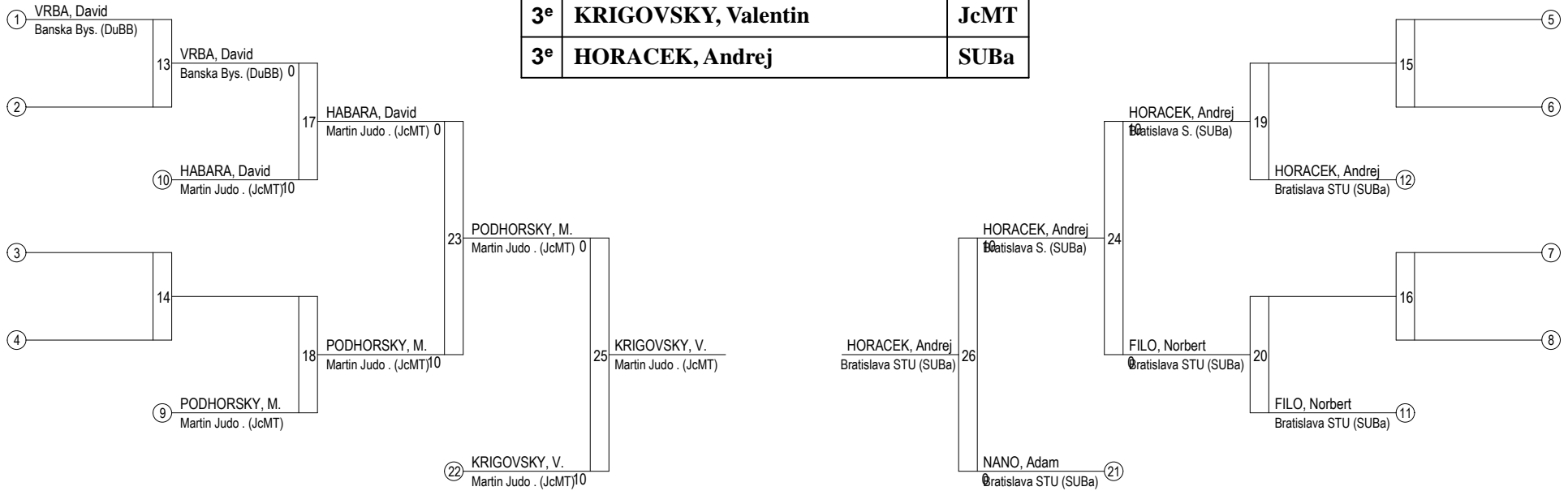

Slovenský zväz JUDO

Liga dorastencov, Liga žien 3. kolo

Weight category: dorastenci -90 kg

	1	2	3	4	5	6	Games won	Pl.
							Gameresults	
SOBKULIAK, Rastislav [Martin Judo Club ZTS (JcMT)]	0		0		0			4
	0		0		0			
KOPIS, Miroslav [Martin Judo Club ZTS (JcMT)]	2			2		2	6	1
	10			10		10	30	
LACH, Jakub [Michalovce SK Zemplin (SKMI)]		0		0	2		2	3
		0		0	10		10	
KURAK, Lukas [Rimavska Sobota TJ Mladost RE]		2	2			0	4	2
		10	10			0	20	

Slovenský zväz JUDO

Liga dorastencov, Liga žien 3. kolo

Weight category: dorastenci +90 kg

	1	2	3	4	5	6	Games won	Pl.
							Gameresults	
HLOBEJ, Ivan [Martin Judo Club ZTS (JcMT)]	2		2		2		6	1
	10		10		10		30	
STROMKO, Lubomir [Martin Judo Club ZTS (JcMT)]	0			0		2	2	3
	0			0		10	10	
KRIZAK, Marian [Michalovce SK Zemplin (SKMI)]		2		2	0		4	2
		10		10	0		20	
MIHALIK, Jakub [Bratislava STU (SUBa)]		0	0			0		4
		0	0			0		

Slovenský zväz JUDO

Liga dorastencov, Liga žien 3. kolo

Weight category: zeny -48 kg

	1	2	3	Games won	Pl.
				Gameresults	
KINCELOVA, Dominika [Vranov Nad Toplou MSK (VnT)]	2	2		4	1
	10	10		20	
MORONGOVA, Miroslava [Vranov Nad Toplou MSK (VnT)]	0		2	2	2
	0		10	10	
MULLEROVA, Nikoleta [Rimavska Sobota TJ Mladost RELAX]		0	0		3
		0	0		

Slovenský zväz JUDO

Liga dorastencov, Liga žien 3. kolo

Weight category: zeny -52 kg

	1	2	3	4	5	6	Games won	Pl.
							Gameresults	
RYDZA, Barbora [Dubnica Nad Váhom ZTS (DnV)]	0		2		2		4	2
	0		10		10		20	
RYDZA, Tereza [Dubnica Nad Váhom ZTS (DnV)]	2			2		2	6	1
	10			7		10	27	
HLADOVA, Michaela [Vranov Nad Toplou MSK (VnT)]		2		0	0		2	3
		10		0	0		10	
SKORSEPOVA, Nina [Bratislava STU (SUBa)]		0	0			0		4
		0	0			0		

Slovenský zväz JUDO

Liga dorastencov, Liga žien 3. kolo

Weight category: ženy -57 kg



1 ^e	MUZIKOVA, Magdalena	SUBa
2 ^e	KANATOVA, Sofia	SUBa
3 ^e	ARENDACOVA, Zuzana	VnT
3 ^e	MIKOVA, Viktoria	VnT

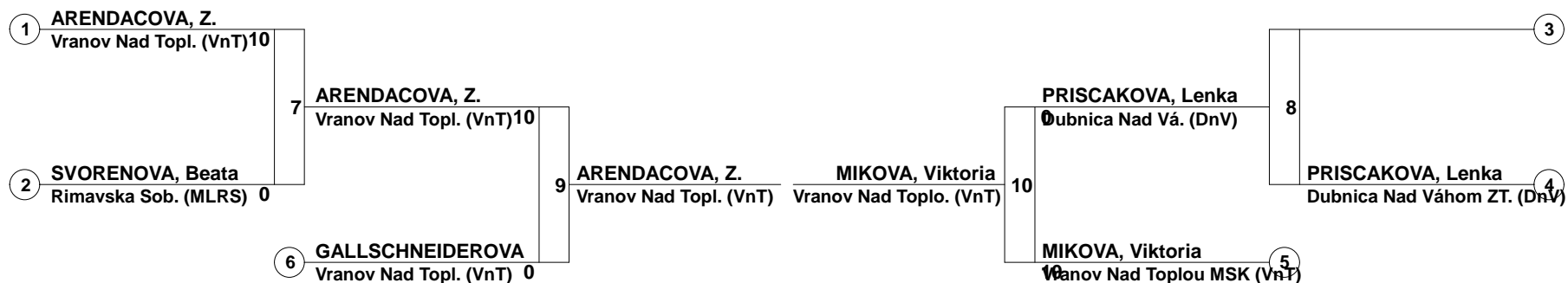

Slovenský zväz JUDO

Liga dorastencov, Liga žien 3. kolo

Weight category: ženy -63 kg

	1	2	3	4	5	6	7	8	9	10	Games won	Pl.
											Gameresults	
MAJOROSOVA, Viktoria [Bratislava STU (SUBa)]	2		2			0			2		6	2
	10		1			0			10		21	
CZIBULOVA, Karin [Bratislava STU (SUBa)]	0			0			2			0	2	4
	0			0			10			0	10	
KOMLOSIOVA, Ivana [Dubnica Nad Váhom ZTS (DnV)]		2		2		2		2			8	1
		10		10		10		10			40	
VAVREKOVA, Daniela [Vranov Nad Toplou MSK (VnT)]		0			0		0		0			5
		0			0		0		0			
OCENASOVA, Zuzana [Rimavska Sobota TJ Mladost RELA]			0		2			0		2	4	3
			0		10			0		10	20	

Slovenský zväz JUDO

Liga dorastencov, Liga žien 3. kolo

Weight category: zeny +63 kg



1 ^e	JAKUBCOVA, Adela	SUBa
2 ^e	ALMASIOVA, Natalia	SUBa
3 ^e	KORENOVA, Eva	VnT
3 ^e	VARADYOVA, Martina	VnT

