



# European Cup Cadets Zagreb 2015

Zagreb (CRO) 14-15 February 2015

			-40	-44	-48	-52	-57	-63	-70	+70		-50	-55	-60	-66	-73	-81	-90	+90			
1.		AUT Austria								0		2	1		1			1		5	5	
2.		BIH Bosnia-Herzegovina			2		2	1	2	7		1		1	2	2	2		2	2	10	17
3.		BLR Belarus					1			1										0	1	
4.		BUL Bulgaria	1	1		2	1	1	1	7		3	2	4	2	1		1	1	14	21	
5.		CRO Croatia		1	5	4	8	5	3	3	29	4	8	12	21	16	10	1	2	74	103	
6.		CYP Cyprus								0		1	1							2	2	
7.		CZE Czech Republic			1	1	1			1	4	1	1	1	1					4	8	
8.		ESP Spain								0					1					1	1	
9.		EST Estonia								0					1					1	1	
10.		FRA France	1	1	2	2	2	2	2	2	14	2	2	2	2	1	2	2	1	14	28	
11.		GBR Great Britain		1			1			2										0	2	
12.		GER Germany			1	1		1	1	4			1							1	5	
13.		HUN Hungary		3	3	2	3	2	3	1	17	6	5	10	9	4	3	3	2	42	59	
14.		IJF International Judo Federati					1			1										0	1	
15.		ISR Israel								0		3	4	3	3	2	3	2	1	21	21	
16.		ITA Italy	1	2	5	7	6	5	3	1	30	3	7	6	6	5	2	3		32	62	
17.		LTU Lithuania						1	1	2		1	1	2	2	1	1	2	1	11	13	
18.		MDA Moldova								0				1	2	1				4	4	
19.		MKD Macedonia			1		2			3				1						1	4	
20.		MNE Montenegro				1	1	3	1	6				2		3	1			6	12	
21.		POL Poland		1	1	2	4	1		1	10	1	1		1	3	1	2	1	10	20	
22.		ROU Romania		1		2	3	3	1	1	11	2	4	4	5	4	1		1	21	32	
23.		RUS Russia						1		1				2	2					4	5	
24.		SLO Slovenia		1	2	4	5	2	3	1	18	1	3	5	11	7	2	3		32	50	
25.		SRB Serbia		2	4	2	1	2	2	13			3	2	7	4	2	4	2	24	37	
26.		SVK Slovakia		1			1			2				2		1	1	1		5	7	
27.		UKR Ukraine	1	2	4	1	2	2	2	1	15	2	3	2	3	1	3	1	1	16	31	
			4	17	31	31	45	32	25	12	197	33	47	62	82	56	34	26	15	355	552	



# European Cup Cadets Zagreb 2015

Zagreb (CRO) 14-15 February 2015

## -50 kg

1.	BINHAK, Tomas	CZE	
2.	D ANGELO, Biagio	ITA	
3.	LUNCAN, Vlad	ROU	
3.	MARIASSE, El Mehdi	FRA	
5.	KHALMATOV, Dilshot	UKR	
5.	KLEIN, Itay	ISR	
7.	FECZKO, Botond	HUN	
7.	PUSIC, David	BIH	

## -55 kg

1.	IVANOV, Denislav	BUL	
2.	GOLOMB, Tomer	ISR	
3.	AHARON, Alon	ISR	
3.	CARLINO, Luca	ITA	
5.	PYLYPIAK, Ivan	UKR	
5.	RAYNARD, Alix	FRA	
7.	GRIGORESCU, Andrei	ROU	
7.	PONGRACZ, Bence	HUN	

## -60 kg

1.	LOMBARDO, Manuel	ITA	
2.	KOZMA, Akos	HUN	
3.	CAGGIANO, Luca	ITA	
3.	GUNICS, Endre	HUN	
5.	KHLOPETSKYI, Danylo	UKR	
5.	SELEA, Florin	ROU	
7.	BOBOVICH, Amit	ISR	
7.	DAYAN, Amir	ISR	

## -66 kg

1.	MANUKIAN, Gievorg	UKR	
2.	CZIZSEK, Mathias	AUT	
3.	JURKOVIC, Ivo	SLO	
3.	TSIUKH, Dmytro	UKR	
5.	GRIGORESCU, Mihai	ROU	
5.	TERELESHKO, Vladyslav	UKR	
7.	GABUN, Constantin	MDA	
7.	ZEMA, Riccardo	ITA	

## -73 kg

1.	PARLATI, Christian	ITA	
2.	CHERKAI, Oleksandr	UKR	
3.	AMIR, Itamar	ISR	
3.	RUDII, Vadim	MDA	
5.	KROGULSKI, Maciej	POL	
5.	SMIDA, Michal	SVK	
7.	RECHISTER, Dilan	ISR	
7.	STOJAK, Filip	BIH	

## -81 kg

1.	AIT MOHAMED AMER, Sofiane	FRA	
2.	SERBAN, Eduard	ROU	
3.	FUSCO, Andrea	ITA	
3.	MILETIC, Toni	BIH	
5.	MAHOMEDOV, Asildar	UKR	
5.	TOTH, Apor	HUN	
7.	SABONIS, Donatas	LTU	
7.	VASYLIEV, Glib	UKR	

## -90 kg

1.	BABENKO, Oleksii	UKR	
2.	DEVOS, Paul	FRA	
3.	KMIELIAUSKAS, Antanas	LTU	
3.	MICIC, Stefan	SRB	
5.	HORVAT, Jan	SLO	
5.	HRISTOV, Hristo	BUL	
7.	LOUZOUN, Almog	ISR	
7.	SCHNEIDER, Sebastian	AUT	

## +90 kg

1.	KOSTIC, Vladimir	SRB	
2.	KRSMANOVIC, Aleksandar	BIH	
3.	FABOS, Kristof	HUN	
3.	MOISIEIEV, Alieksiei	UKR	
5.	HRISTOV, Ventsislav	BUL	
5.	MOLODECKIJ, Aleks	LTU	
7.	BOROVSKY, Dimitry	ISR	
7.	WACZULIK, Richard	HUN	



# European Cup Cadets Zagreb 2015

Zagreb (CRO) 14-15 February 2015

<b>-40 kg</b>		
1.	LAROCHE, Cassandra	FRA
2.	SIVKOVA, Boyana	BUL
3.	TRINA, Sara	ITA
3.		
5.		
5.		
7.		
7.		

<b>-44 kg</b>		
1.	BILODID, Daria	UKR
2.	BOUKLI, Shirine	FRA
3.	PETITTO, Sofia	ITA
3.	PIECHOTA, Olivia	GBR
5.	IONITA, Georgiana	ROU
5.	KINCELOVA, Dominika	SVK
7.	MERCNIK, Ljudmila	SLO
7.	TAMASI, Szandra	HUN

<b>-48 kg</b>		
1.	STANGAR, Marusa	SLO
2.	PONT, Blandine	FRA
3.	PETROVIC, Nadezda	SRB
3.	ZAMPONI, Martina	ITA
5.	KROPSKA, Natalia	POL
5.	MIHALOVITS, Kincso	HUN
7.	STOJADINOV, Andrea	SRB
7.	VUKOVIC, Marija	SRB

<b>-52 kg</b>		
1.	TOPOLOVEC, Tihea	CRO
2.	KAJZER, Kaja	SLO
3.	BOUDOUAIA, Lydia	FRA
3.	KIRILOVA, Plamena	BUL
5.	BROCHOT, Noemie	FRA
5.	SCISCIOLA, Martina	ITA
7.	OSTROVSKA, Anelia	BUL
7.	TROPAN, Teja	SLO

<b>-57 kg</b>		
1.	SZYMANSKA, Angelika	POL
2.	GIRAUD, Marine	FRA
3.	FAVORINI, Flavia	ITA
3.	MINENKOVA, Ulyana	BLR
5.	ANZELAK, Tanja	SLO
5.	LOXHA, Flaka	IJF
7.	FILIPISAN, Anca	ROU
7.	GANGBES, Kesya	FRA

<b>-63 kg</b>		
1.	OBRADOVIC, Jovana	SRB
2.	OBRADOVIC, Anja	SRB
3.	LISONI, Chiara	ITA
3.	SAID ERRHAMANI, Assia	FRA
5.	BABIC, Lucija	CRO
5.	D ISANTO, Nicolle	ITA
7.	KUKHARUK, Hanna	UKR
7.	MILIC, Mirjana	MNE

<b>-70 kg</b>		
1.	PRODAN, Karla	CRO
2.	BORISOVA, Boryana	BUL
3.	OPRESNIK, Petra	SLO
3.	PEKOVIC, Jovana	MNE
5.	HEINZ, Liane	GER
5.	LEBRETON, Candice	FRA
7.	RADMILOVIC, Djurdjina	SRB
7.	SKORA, Kateryna	UKR

<b>+70 kg</b>		
1.	PAULUSOVA, Marketa	CZE
2.	DERROUAZI, Soumaya	FRA
3.	GOBEC, Lea	CRO
3.	SZIGETVARI, Mercedesz	HUN
5.	MOHORIC, Veronika	SLO
5.	PONTY, Sarah	FRA
7.	ORIGGI, Vanessa	ITA
7.	SLOBODIANIUK, Anna	UKR



# European Cup Cadets Zagreb 2015: Medals

Zagreb (CRO) 14-15 February 2015

				1st place	2nd place	3rd place	5th place	7th place
1.		UKR	Ukraine	3	1	2	5	4
2.		FRA	France	2	5	3	4	1
3.		ITA	Italy	2	1	8	2	2
4.		SRB	Serbia	2	1	2	0	3
5.		CRO	Croatia	2	0	1	1	0
6.		CZE	Czech Republic	2	0	0	0	0
7.		BUL	Bulgaria	1	2	1	2	1
8.		SLO	Slovenia	1	1	2	3	2
9.		POL	Poland	1	0	0	2	0
10.		HUN	Hungary	0	1	3	2	4
11.		ISR	Israel	0	1	2	1	5
12.		ROU	Romania	0	1	1	3	2
13.		BIH	Bosnia-Herzegovina	0	1	1	0	2
14.		AUT	Austria	0	1	0	0	1
15.		LTU	Lithuania	0	0	1	1	1
16.		MDA	Moldova	0	0	1	0	1
16.		MNE	Montenegro	0	0	1	0	1
18.		BLR	Belarus	0	0	1	0	0
18.		GBR	Great Britain	0	0	1	0	0
20.		SVK	Slovakia	0	0	0	2	0
21.		GER	Germany	0	0	0	1	0
21.		IJF	International Judo Federation	0	0	0	1	0



# European Cup Cadets Zagreb 2015

Zagreb (CRO) 14-15 February 2015

## -50 kg

33 Judoka

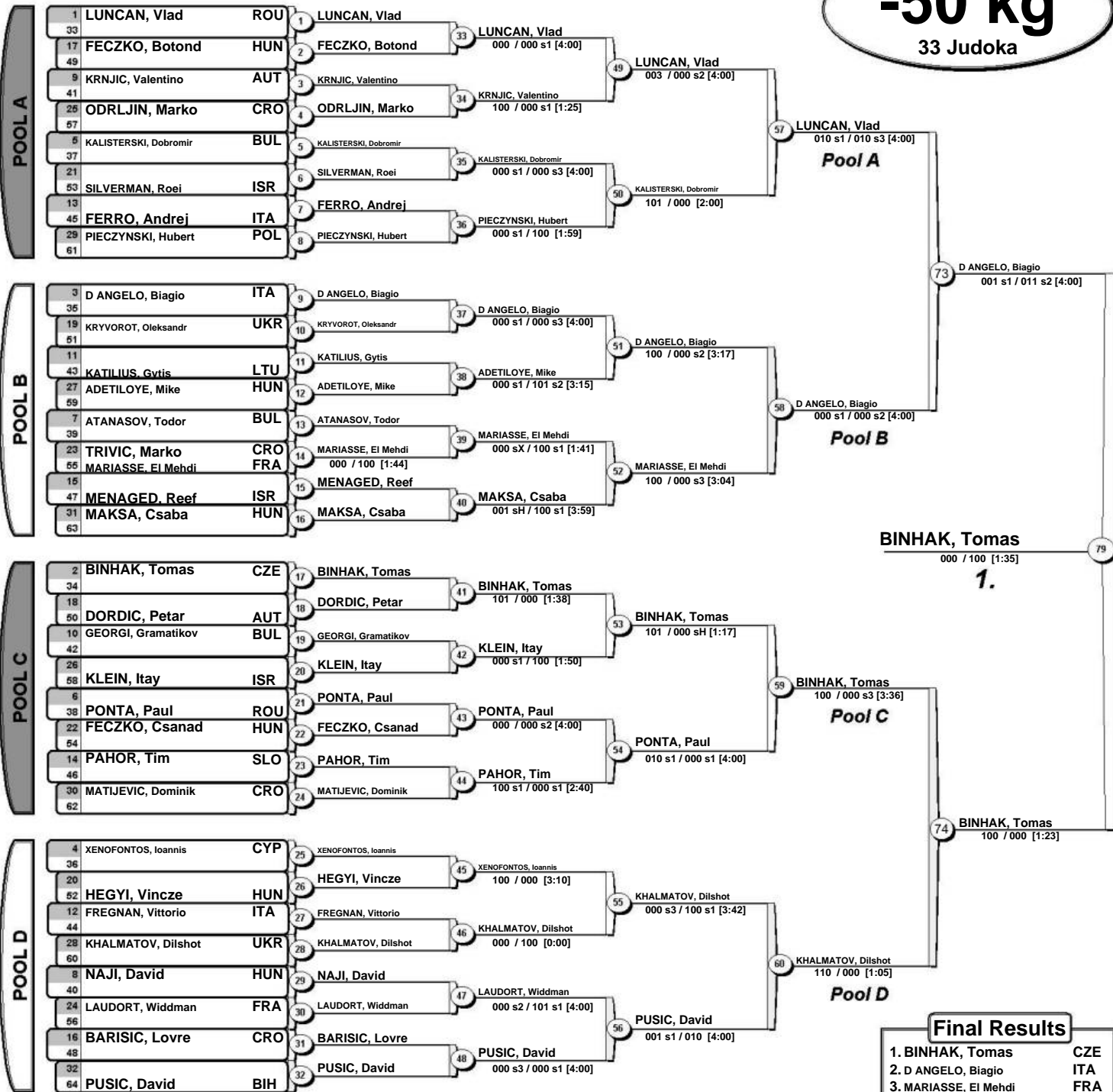

## Repechage

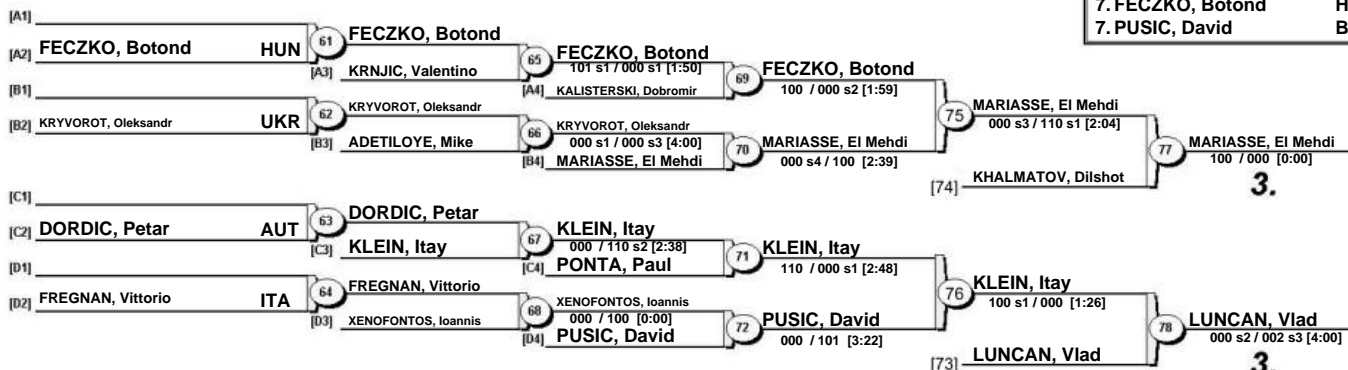



# European Cup Cadets Zagreb 2015

Zagreb (CRO) 14-15 February 2015

**-55 kg**  
47 Judoka

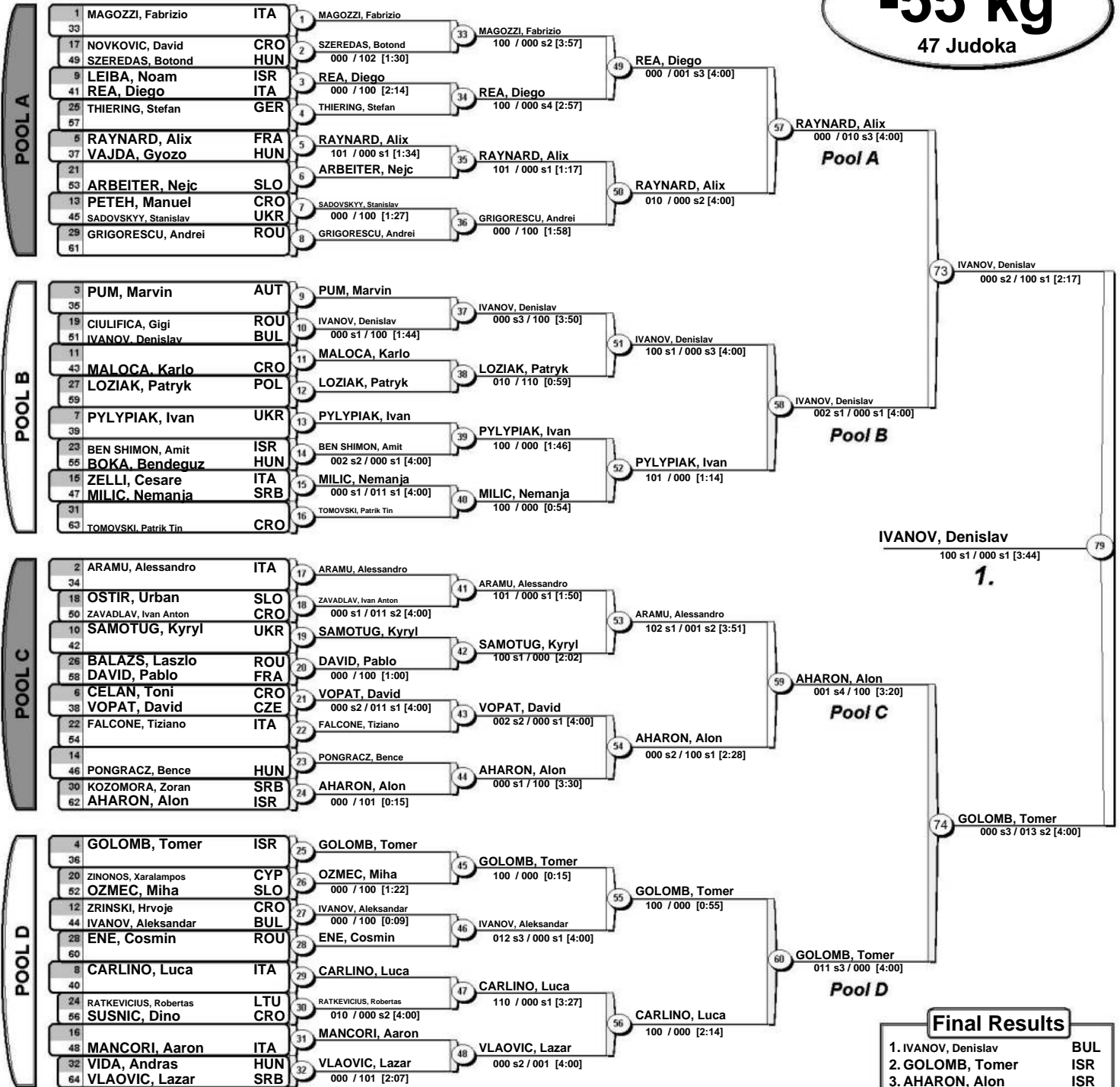

IVANOV, Denislav  
100 s1 / 000 s1 [3:44]

**1.**

### Final Results

1. IVANOV, Denislav BUL
2. GOLOMB, Tomer ISR
3. AHARON, Alon ISR
3. CARLINO, Luca ITA
5. PYLYPIAK, Ivan UKR
7. RAYNARD, Alix FRA
7. GRIGORESCU, Andrei ROU
7. PONGRACZ, Bence HUN

### Repechage

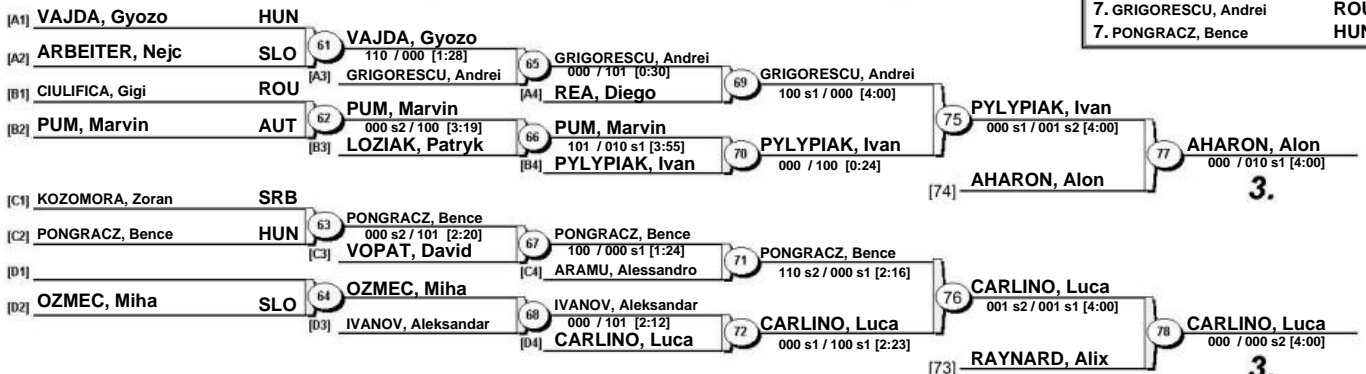



# European Cup Cadets Zagreb 2015

Zagreb (CRO) 14-15 February 2015

## -60 kg

62 Judoka

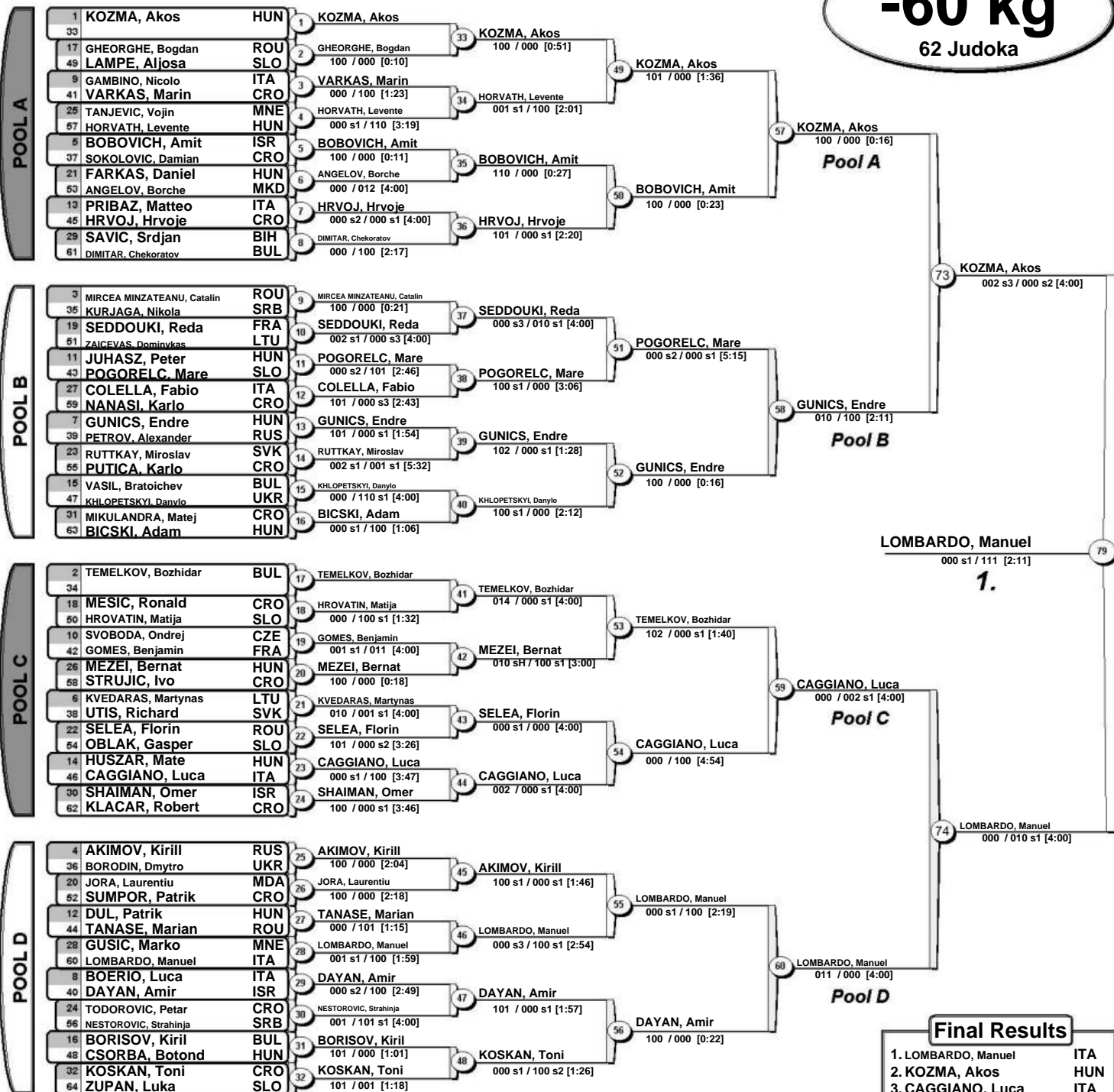

## Repechage

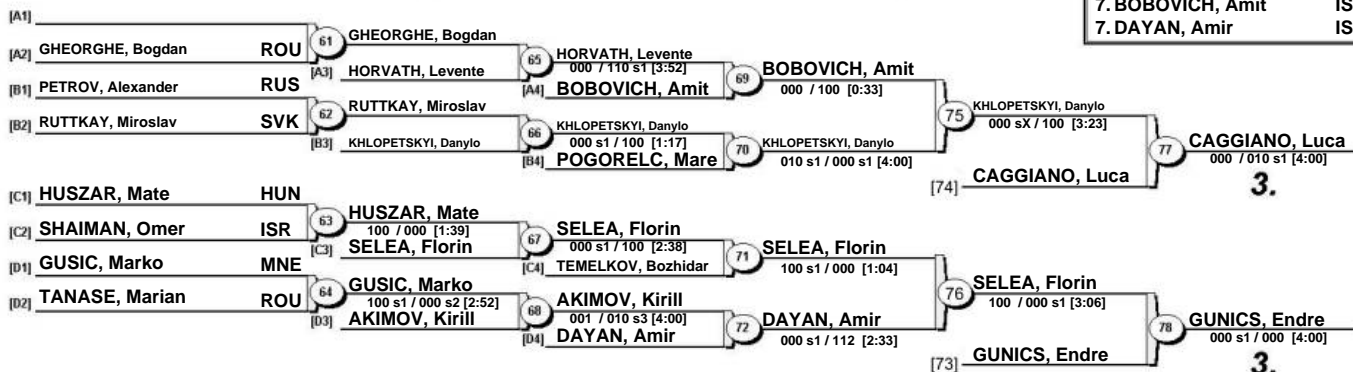



# European Cup Cadets Zagreb 2015

Zagreb (CRO) 14-15 February 2015

A/B

**-66 kg**  
82 Judoka

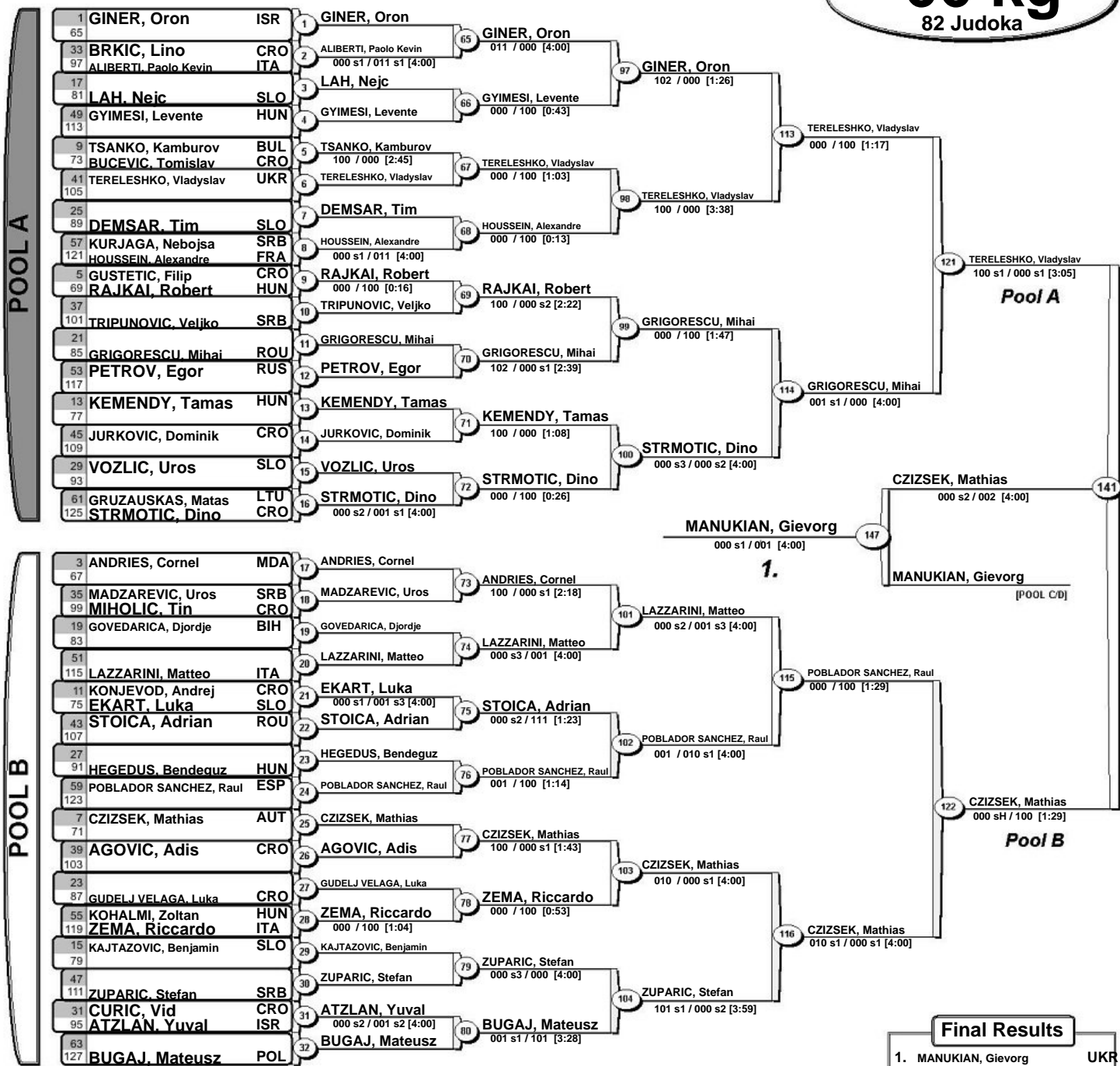

Final Results	
1.	MANUKIAN, Gievorg UKR
2.	CZIZSEK, Mathias AUT
3.	JURKOVIC, Ivo SLO
3.	TSIUKH, Dmytro UKR
5.	GRIGORESCU, Mihai ROU
5.	TERELESKO, Vladyslav UKR
7.	ZEMA, Riccardo ITA
7.	GABUN, Constantin MDA

## Repechage

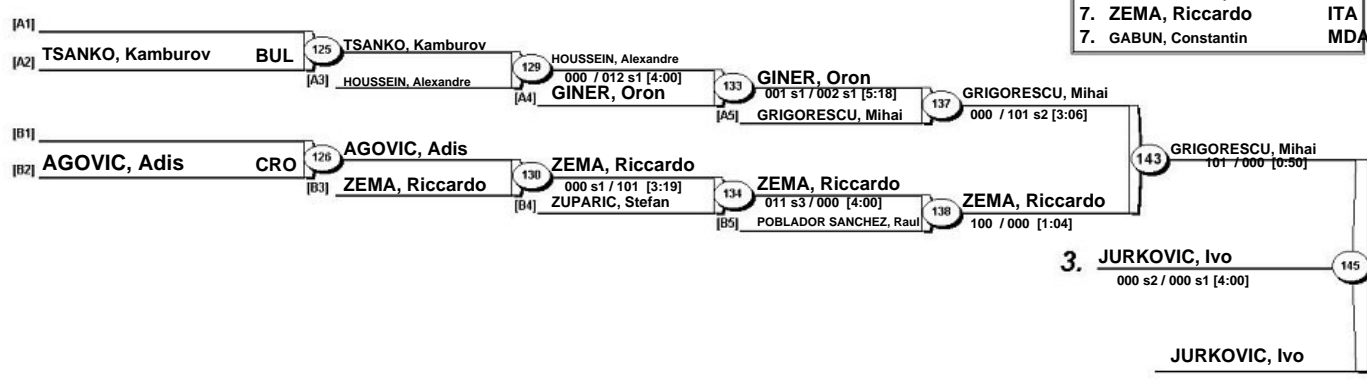





# European Cup Cadets Zagreb 2015

Zagreb (CRO) 14-15 February 2015

C/D

**-66 kg**  
82 Judoka

POOL C

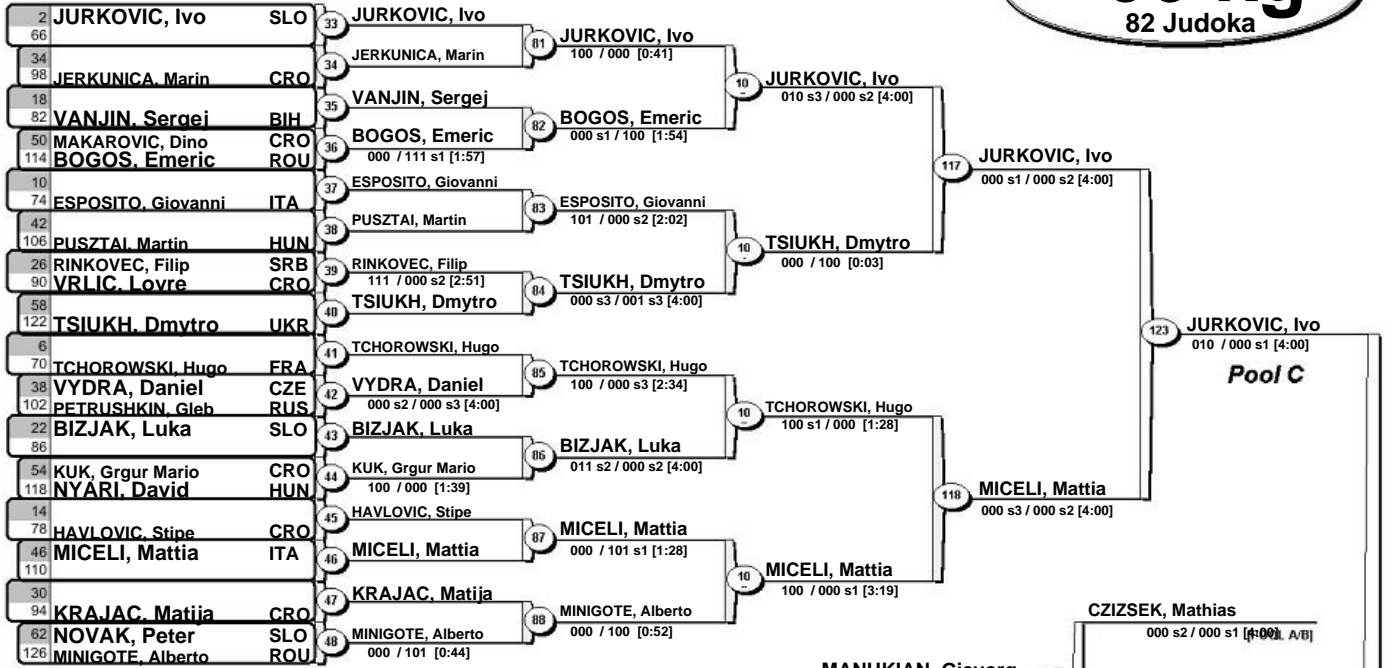

POOL D

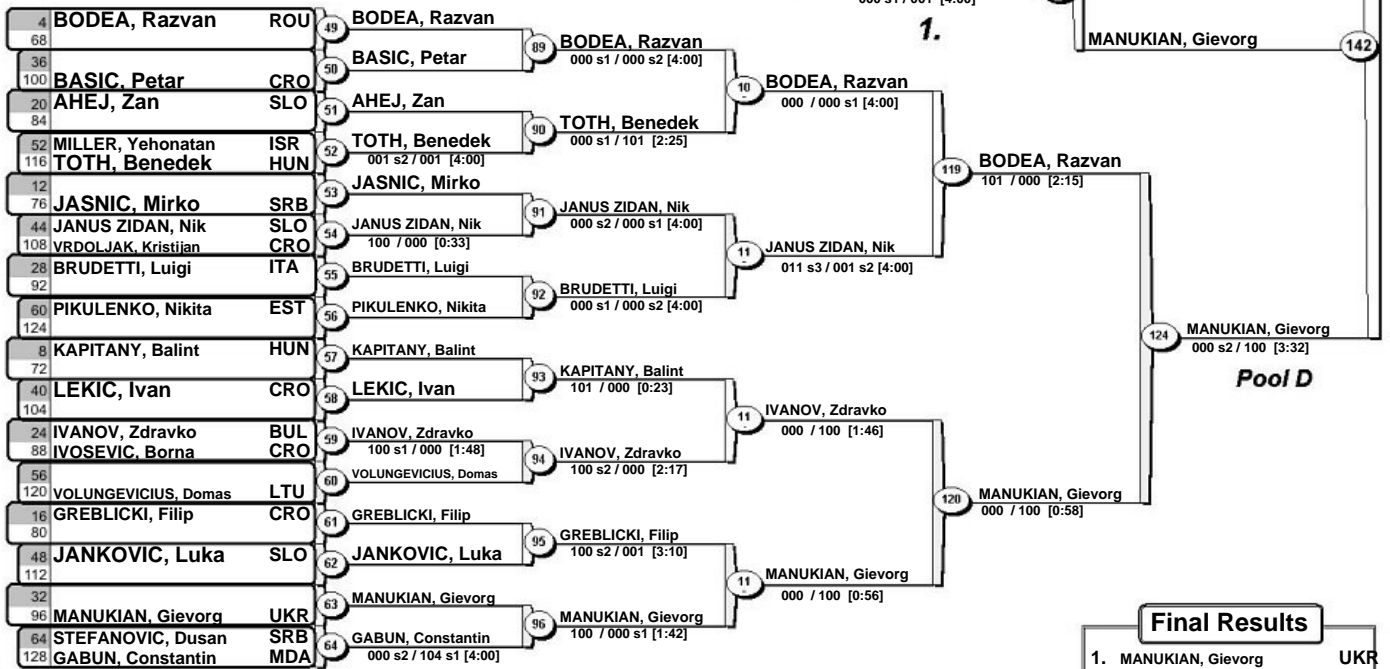

### Final Results

1. MANUKIAN, Gievorg UKR
2. CZIZSEK, Mathias AUT
3. JURKOVIC, Ivo SLO
3. TSIUKH, Dmytro UKR
5. GRIGORESCU, Mihai ROU
5. TERELESHKO, Vladyslav UKR
7. ZEMA, Riccardo ITA
7. GABUN, Constantin MDA

### Repechage

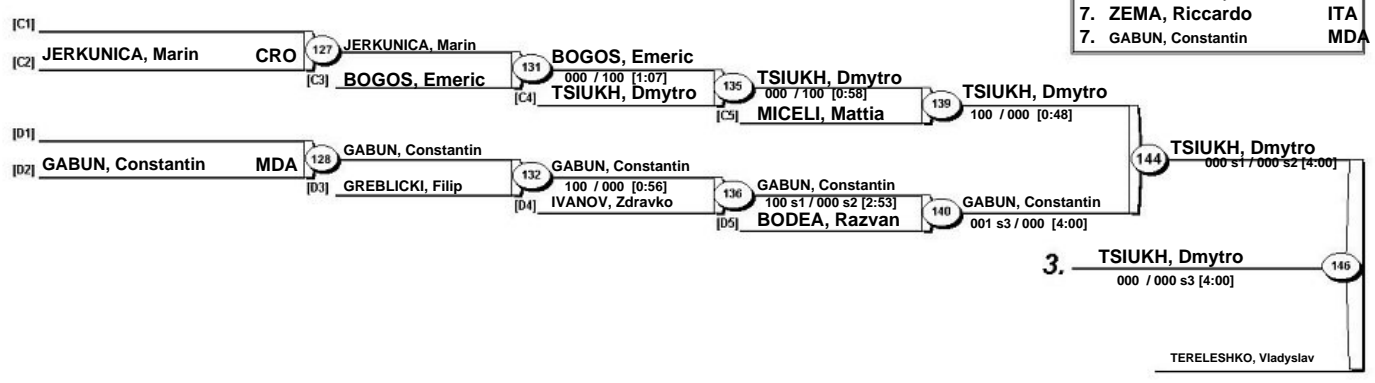



# European Cup Cadets Zagreb 2015

Zagreb (CRO) 14-15 February 2015

# -73 kg

56 Judoka

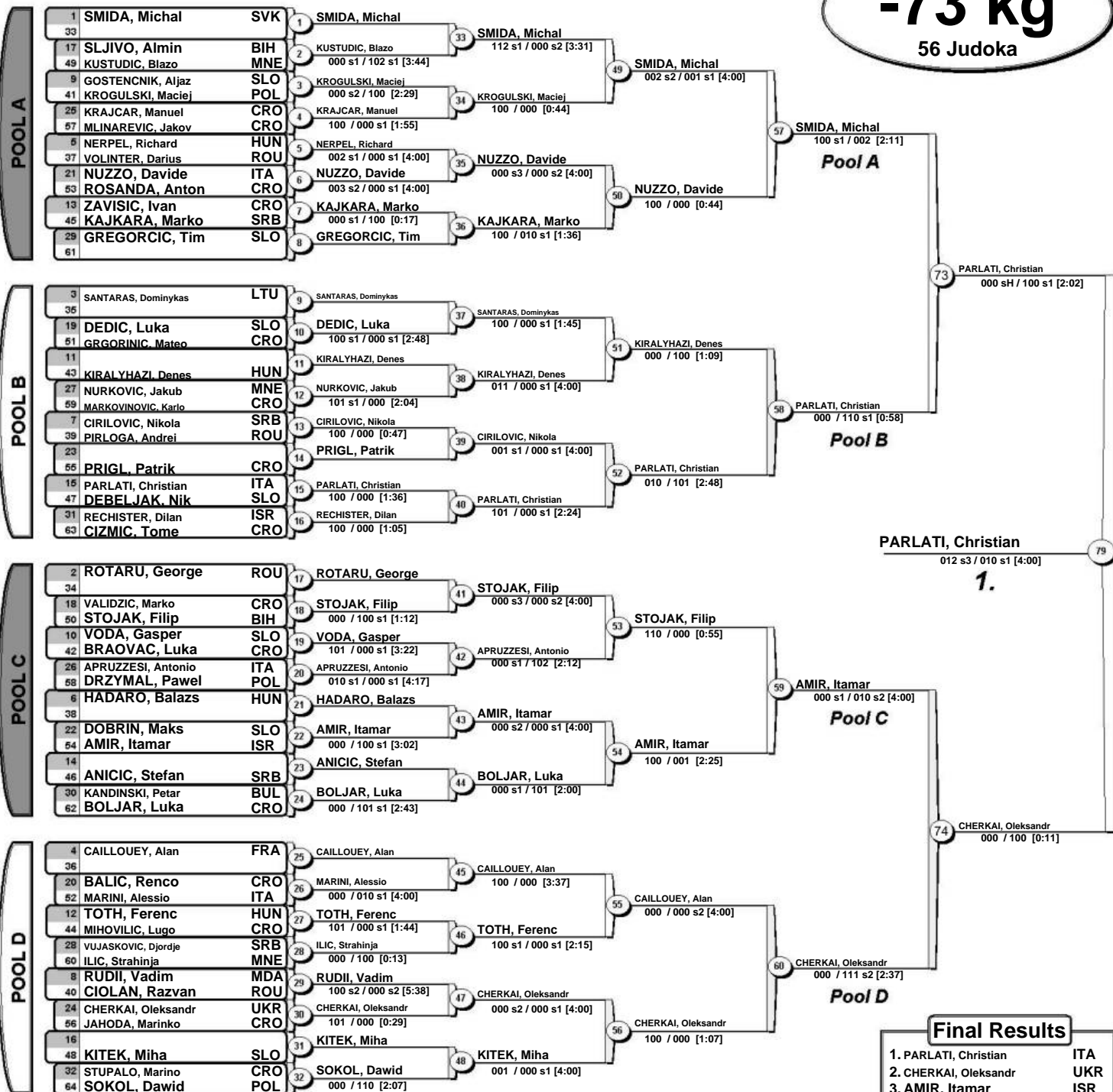

PARLATI, Christian  
012 s3 / 010 s1 [4:00]

1.

### Final Results

- |    |                    |     |
|----|--------------------|-----|
| 1. | PARLATI, Christian | ITA |
| 2. | CHERKAI, Oleksandr | UKR |
| 3. | AMIR, Itamar       | ISR |
| 4. | RUDII, Vadim       | MDA |
| 5. | KROGULSKI, Maciej  | POL |
| 6. | SMIDA, Michal      | SVK |
| 7. | RECHISTER, Dilan   | ISR |
| 8. | STOJAK, Filip      | BIH |



# European Cup Cadets Zagreb 2015

Zagreb (CRO) 14-15 February 2015

## -81 kg

34 Judoka

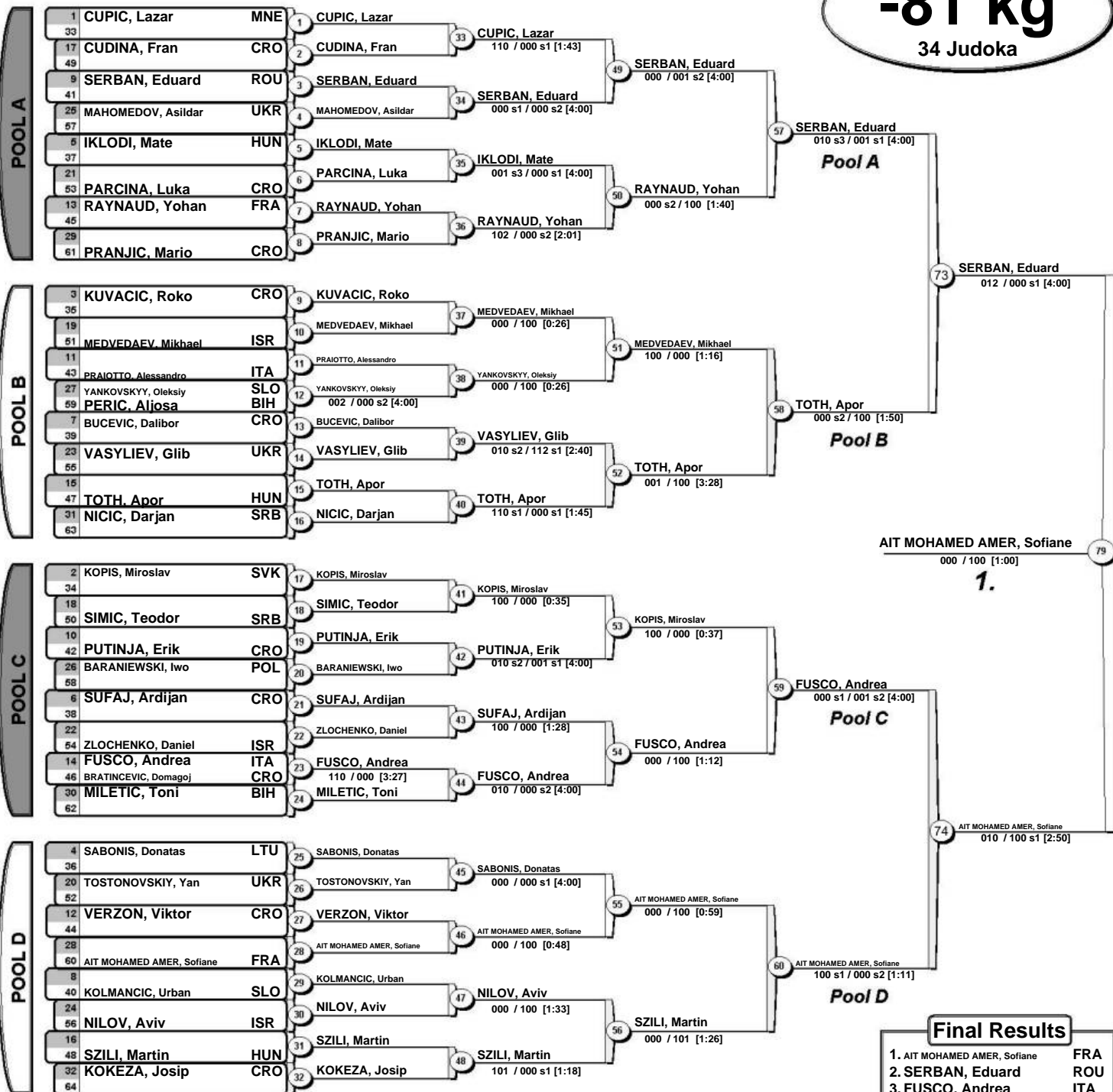

## Repechage

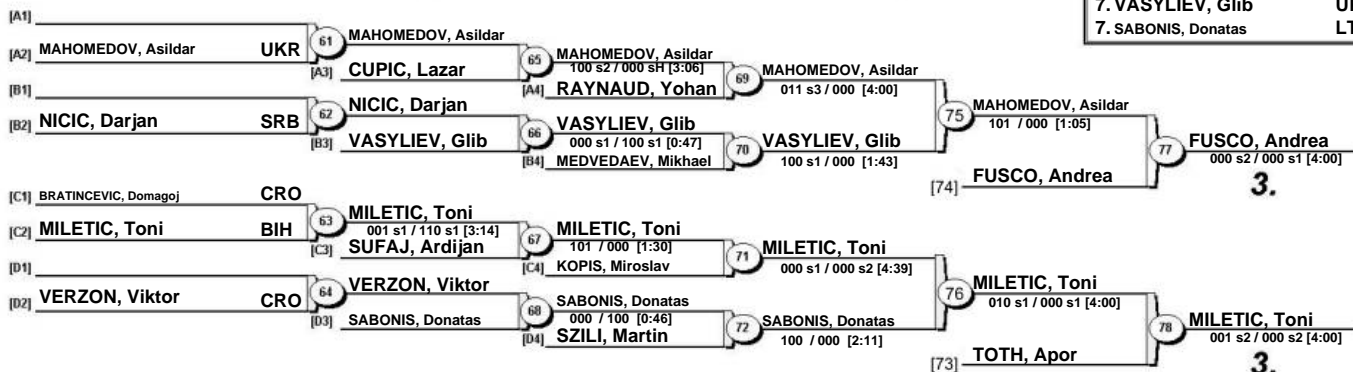



# European Cup Cadets Zagreb 2015

Zagreb (CRO) 14-15 February 2015

## -90 kg

26 Judoka

POOL A

1	KMIELIAUSKAS, Antanas	LTU	1	KMIELIAUSKAS, Antanas
17			17	KMIELIAUSKAS, Antanas
9	BERBATTI, Stefano	ITA	2	BERBATTI, Stefano
25	GERL KORENC, Jan	SLO	2	100 / 000 s1 [2:15]
5	KOVACEVIC, Vasilije	SRB	3	HRISTOV, Hristo
21	HRISTOV, Hristo	BUL	3	000 / 100 s1 [2:48]
13	TOTH, Csaba	HUN	4	TOTH, Csaba
29			4	

25 HRISTOV, Hristo  
000 / 100 [1:24]  
**Pool A - Winner**  
Vainqueur / Sieger

POOL B

3	DEVOS, Paul	FRA	5	DEVOS, Paul
19	RYCIAK, Eryk	POL	5	100 s1 / 010 sH [1:46]
11	LOUZOUN, Almog	ISR	6	LOUZOUN, Almog
27	KURAK, Lukas	SVK	6	101 s1 / 001 s1 [3:18]
7	BRASNOVIC, Darko	SRB	7	BRASNOVIC, Darko
23	MILOSEVIC, Damjan	CRO	7	110 / 000 s3 [3:34]
15			8	GALAMBOS, Milan
31	GALAMBOS, Milan	HUN	8	

19 DEVOS, Paul  
110 / 000 s1 [2:06]  
26 DEVOS, Paul  
110 s2 / 001 [2:45]  
**Pool B - Winner**  
Vainqueur / Sieger

POOL C

2	MICIC, Stefan	SRB	9	MICIC, Stefan
18			9	
10	RUIMI, Ziv	ISR	10	RUIMI, Ziv
26	KEJZA, Pawel	POL	10	010 s2 / 000 s1 [4:00]
6			11	MELIS, Stefano
22	MELIS, Stefano	ITA	11	
14			12	BABENKO, Oleksii
30	BABENKO, Oleksii	UKR	12	

21 MICIC, Stefan  
100 / 000 [1:16]  
27 BABENKO, Oleksii  
000 s1 / 100 [1:59]  
**Pool C - Winner**  
Vainqueur / Sieger

POOL D

4	SCHNEIDER, Sebastian	AUT	13	SCHNEIDER, Sebastian
20			13	
12	PRAGLIOLA, Francesco	ITA	14	HORVAT, Jan
28	HORVAT, Jan	SLO	14	000 / 100 [0:30]
8	GACESA, Luka	SRB	15	GACESA, Luka
24	VAKALAS, Aldas	LTU	15	100 / 001 [1:26]
16	ARVAI, Peter	HUN	16	THOME, Dorian
32	THOME, Dorian	FRA	16	011 s2 / 111 [3:58]

23 HORVAT, Jan  
000 / 100 s1 [1:03]  
28 HORVAT, Jan  
100 / 000 [0:35]  
**Pool D - Winner**  
Vainqueur / Sieger

BABENKO, Oleksii

1.

38 BABENKO, Oleksii  
101 / 000 [0:18]

### Results Résultat / Platzierungen

1. BABENKO, Oleksii UKR
2. DEVOS, Paul FRA
3. KMIELIAUSKAS, Antanas LTU
3. MICIC, Stefan SRB
5. HORVAT, Jan SLO
5. HRISTOV, Hristo BUL
7. LOUZOUN, Almog ISR
7. SCHNEIDER, Sebastian AUT

Repechage / Trostrunde

[A1]	KOVACEVIC, Vasilije	SRB	29	KOVACEVIC, Vasilije
[A2]	TOTH, Csaba	HUN	29	110 s2 / 000 [2:43]
[A3]			33	KMIELIAUSKAS, Antanas
[B1]	RYCIAK, Eryk	POL	[A3]	KMIELIAUSKAS, Antanas
[B2]	LOUZOUN, Almog	ISR	30	LOUZOUN, Almog
[B3]			34	LOUZOUN, Almog
[C1]			[B3]	BRASNOVIC, Darko
[C2]	MELIS, Stefano	ITA	31	MELIS, Stefano
[C3]			35	MICIC, Stefan
[D1]	PRAGLIOLA, Francesco	ITA	[C3]	MICIC, Stefan
[D2]	SCHNEIDER, Sebastian	AUT	32	SCHNEIDER, Sebastian
[D3]			36	SCHNEIDER, Sebastian
[D3]				THOME, Dorian

[38] HORVAT, Jan

3.

[37] HRISTOV, Hristo

3.



# European Cup Cadets Zagreb 2015

Zagreb (CRO) 14-15 February 2015

## +90 kg

15 Judoka

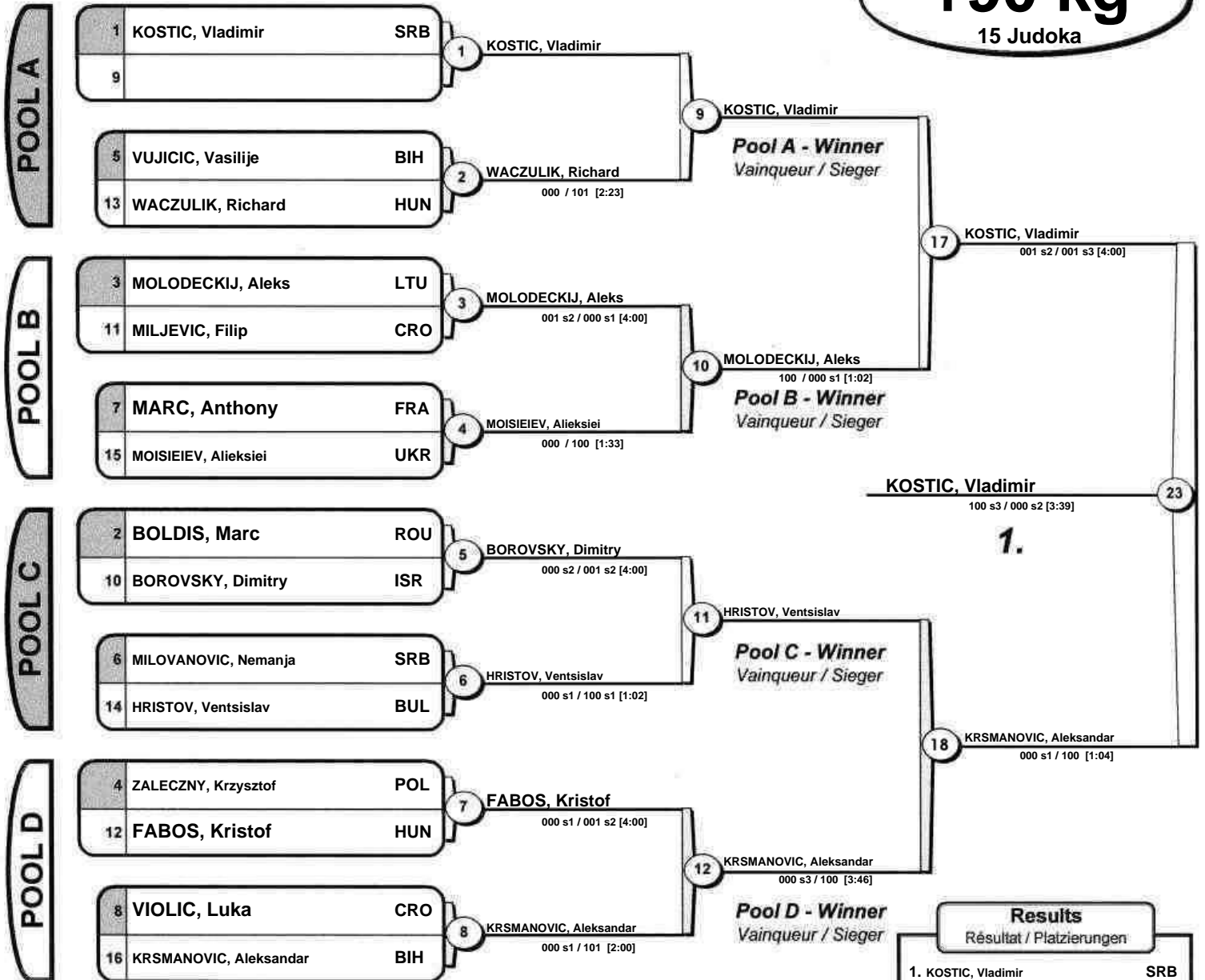

Results	
Résultat / Platzierungen	
1. KOSTIC, Vladimir	SRB
2. KRSMANOVIC, Aleksandar	BIH
3. MOISIEIEV, Alieksiei	UKR
3. FABOS, Kristof	HUN
5. HRISTOV, Ventsislav	BUL
5. MOLODECKIJ, Aleks	LTU
7. WACZULIK, Richard	HUN
7. BOROVSKY, Dimitry	ISR

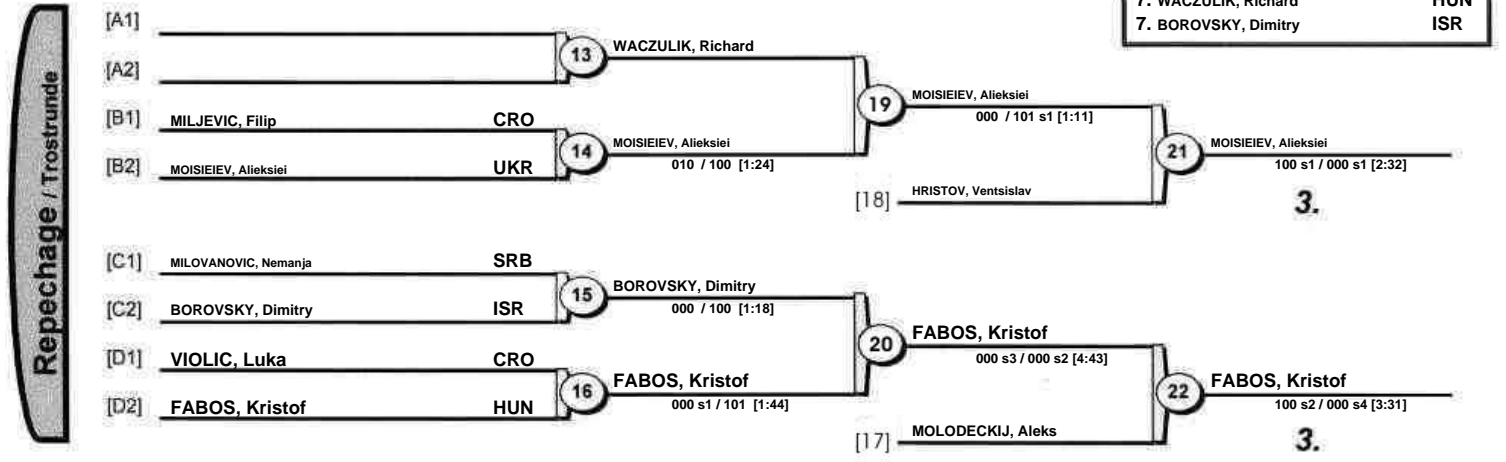



# European Cup Cadets Zagreb 2015

Zagreb (CRO) 14-15 February 2015

**-40 kg**  
4 Judoka

			1	2	3	4			
1	SIVKOVA, Boyana	BUL		-	+	+	2		
					(10)	(100)	(110)		
2	LAROCHE, Cassandra	FRA	+		+	+	3		
			(100)		(100)	(100)	(300)		
3	TRINA, Sara	ITA	-	-		+	1		
						(0.5)	(0.5)		
4	SEMENIUK, Alona	UKR	-	-	-		(0)		

1 SIVKOVA, Boyana BUL      1 LAROCHE, Cassandra FRA  
2 LAROCHE, Cassandra FRA      000 / 100 [0:55]

3 TRINA, Sara ITA      2 TRINA, Sara ITA  
4 SEMENIUK, Alona UKR      000 / 000 s3 [4:00]

1 SIVKOVA, Boyana BUL      3 SIVKOVA, Boyana BUL  
3 TRINA, Sara ITA      011 s1 / 000 s1 [4:00]

2 LAROCHE, Cassandra FRA      4 LAROCHE, Cassandra FRA  
4 SEMENIUK, Alona UKR      100 / 000 [0:19]

1 SIVKOVA, Boyana BUL      5 SIVKOVA, Boyana BUL  
4 SEMENIUK, Alona UKR      100 s1 / 000 s1 [1:06]

2 LAROCHE, Cassandra FRA      6 LAROCHE, Cassandra FRA  
3 TRINA, Sara ITA      100 / 000 [0:27]

## Final Results

1. LAROCHE, Cassandra FRA
2. SIVKOVA, Boyana BUL
3. TRINA, Sara ITA



# European Cup Cadets Zagreb 2015

Zagreb (CRO) 14-15 February 2015

## -44 kg

17 Judoka

POOL A

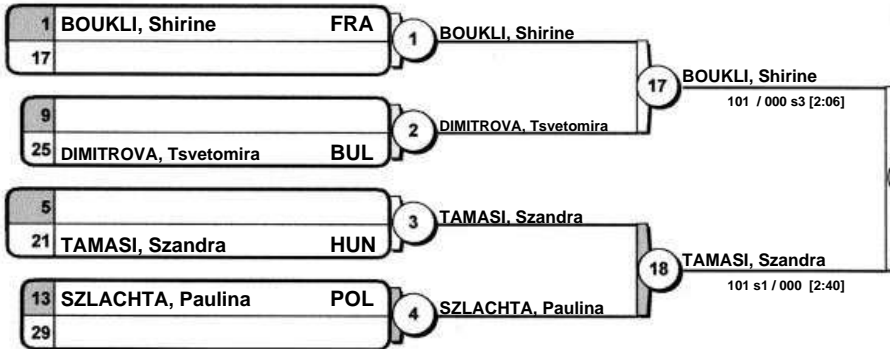

**Pool A - Winner**  
Vainqueur / Sieger

POOL B

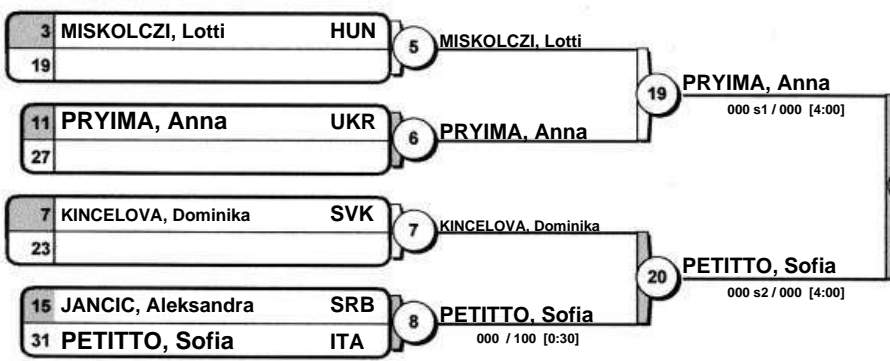

**Pool B - Winner**  
Vainqueur / Sieger

POOL C



**Pool C - Winner**  
Vainqueur / Sieger

POOL D

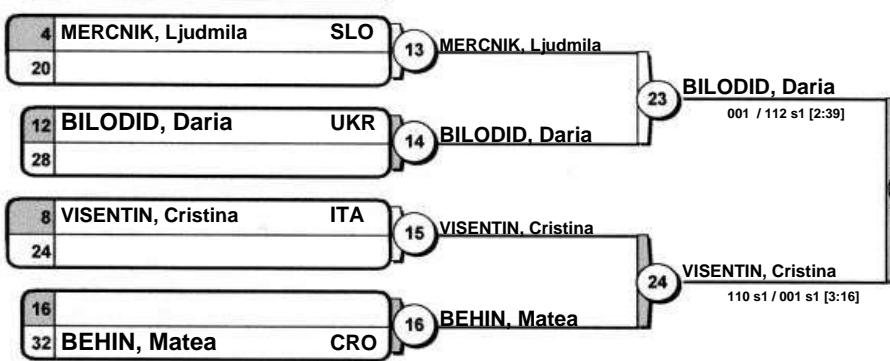

**Pool D - Winner**  
Vainqueur / Sieger

BILODID, Daria



1.

38 BILODID, Daria (000 s2 / 002 s2 [4:00])

Results	
Résultat / Platzierungen	
1.	BILODID, Daria UKR
2.	BOUKLI, Shirine FRA
3.	PIECHOTA, Olivia GBR
3.	PETITTO, Sofia ITA
5.	KINCELOVA, Dominika SVK
5.	IONITA, Georgiana ROU
7.	TAMASI, Szandra HUN
7.	MERCNIK, Ljudmila SLO

Repechage / Trostrunde

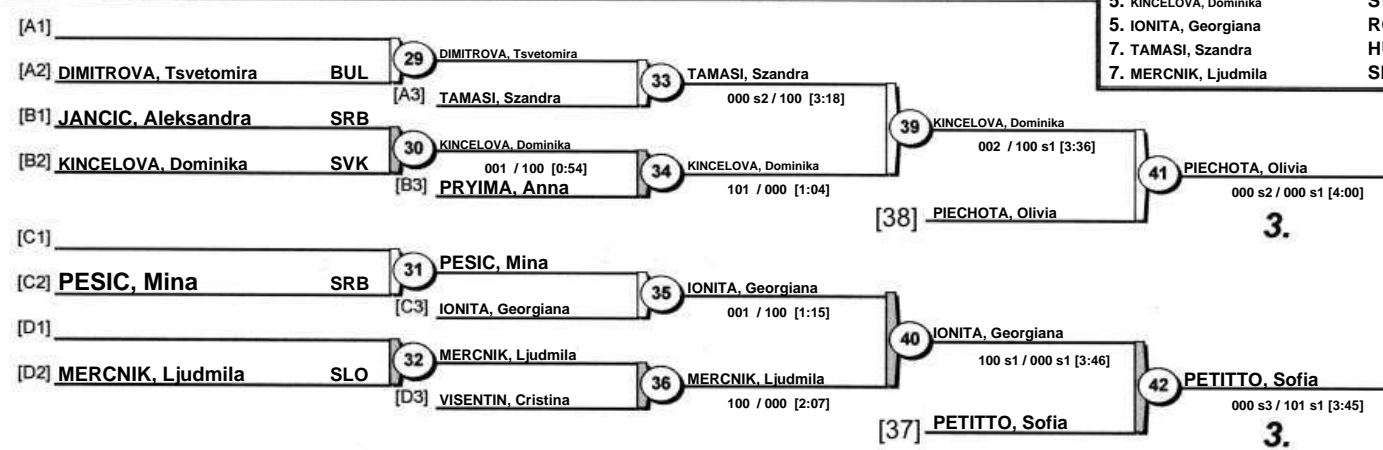

3.

3.



# European Cup Cadets Zagreb 2015

Zagreb (CRO) 14-15 February 2015

## -48 kg

31 Judoka

POOL A

1	STANGAR, Marusa	SLO	1	STANGAR, Marusa
17				
9	ZARKOVIC, Martina	CRO	2	STOJADINOV, Andrea
25	STOJADINOV, Andrea	SRB		000 / 100 [0:43]
5	PALYVODA, Anzhelika	UKR	3	KOPASZ, Fanni
21	KOPASZ, Fanni	HUN		000 s1 / 100 [1:50]
13	SORMAZ, Vanja	BIH	4	MARCUS TABELLION, Coraline
29	MARCUS TABELLION, Coraline	FRA		000 / 100 [0:18]

POOL B

3	MIHALOVITS, Kincso	HUN	5	MIHALOVITS, Kincso
19	BRANKOVIC, Barbara	CRO		100 / 000 [0:41]
11	SABLIEVA, Kateryna	UKR	6	KROPSKA, Natalia
27	KROPSKA, Natalia	POL		000 s2 / 001 s1 [4:00]
7	SANTINI, Giulia	ITA	7	SANTINI, Giulia
23	CHATZIASTROS, Lena	GER		101 / 000 [1:14]
15	IVKOVIC, Marija	SRB	8	IVKOVIC, Marija
31	FARINA, Veronica	ITA		100 s1 / 000 [3:01]

POOL C

2	PONT, Blandine	FRA	9	PONT, Blandine
18	BRKIC, Ana Marija	BIH		101 / 000 s1 [1:25]
10	BOCCOLA, Rossella	ITA	10	PETROVIC, Nadezda
26	PETROVIC, Nadezda	SRB		000 / 100 [1:02]
6	MLINARIC, Margareta	CRO	11	ZACHOVA, Renata
22	ZACHOVA, Renata	CZE		001 s1 / 001 [4:32]
14	BULASHEVYCH, Mariia	UKR	12	MAROTI, Alexandra
30	MAROTI, Alexandra	HUN		000 s1 / 001 s1 [4:32]

POOL D

4	ZAMPONI, Martina	ITA	13	ZAMPONI, Martina
20	BRLETIC, Matea	CRO		111 / 000 [2:24]
12	RANC, Sasa	SLO	14	VASHCHENKO, Lidiya
28	VASHCHENKO, Lidiya	UKR		000 s1 / 102 s1 [3:47]
8	VUKOVIC, Marija	SRB	15	VUKOVIC, Marija
24	GRADISEK, Veronika	CRO		101 s1 / 000 s1 [1:40]
16	CASTAGNOLA, Martina	ITA	16	REXHEPI, Arbresha
32	REXHEPI, Arbresha	MKD		000 s1 / 100 [4:00]

STANGAR, Marusa

110 / 000 [3:39]

1.

Pool C - Winner  
Vainqueur / Sieger

Pool D - Winner  
Vainqueur / Sieger

PONT, Blandine

100 s1 / 000 s1 [3:22]

**Results**  
Résultat / Platzierungen

- STANGAR, Marusa SLO
- PONT, Blandine FRA
- ZAMPONI, Martina ITA
- PETROVIC, Nadezda SRB
- KROPSKA, Natalia POL
- MIHALOVITS, Kincso HUN
- STOJADINOV, Andrea SRB
- VUKOVIC, Marija SRB

Repechage / Trostrunde

[A1]		29	STOJADINOV, Andrea	33	STOJADINOV, Andrea	
[A2]	STOJADINOV, Andrea	SRB			002 / 000 [1:14]	
[B1]	BRANKOVIC, Barbara	CRO	[A3]	MARCUS TABELLION, Coraline		
[B2]	KROPSKA, Natalia	POL	30	KROPSKA, Natalia	34	KROPSKA, Natalia
			[B3]	IVKOVIC, Marija		100 / 000 [1:05]
[C1]	BRKIC, Ana Marija	BIH	31	PETROVIC, Nadezda	35	PETROVIC, Nadezda
[C2]	PETROVIC, Nadezda	SRB		000 / 100 [1:32]		000 / 000 s1 [4:39]
[D1]	BRLETIC, Matea	CRO	[C3]	MAROTI, Alexandra		
[D2]	VASHCHENKO, Lidiya	UKR	32	BRLETIC, Matea	40	PETROVIC, Nadezda
			[D3]	VUKOVIC, Marija		100 / 000 [0:47]
				000 s1 / 000 s2 [4:00]		000 s1 / 100 s1 [1:26]
				000 s1 / 100 [4:00]		
					37	MIHALOVITS, Kincso
						100 / 001 [1:19]

3.

3.





# European Cup Cadets Zagreb 2015

Zagreb (CRO) 14-15 February 2015

## -52 kg

31 Judoka

POOL A

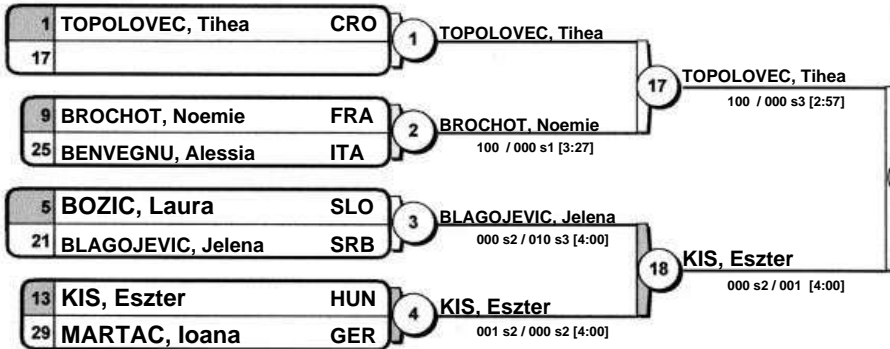

**Pool A - Winner**  
Vainqueur / Sieger

POOL B

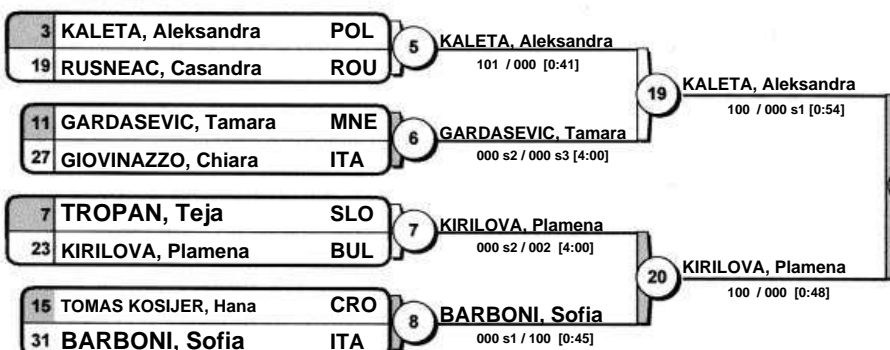

**Pool B - Winner**  
Vainqueur / Sieger

POOL C

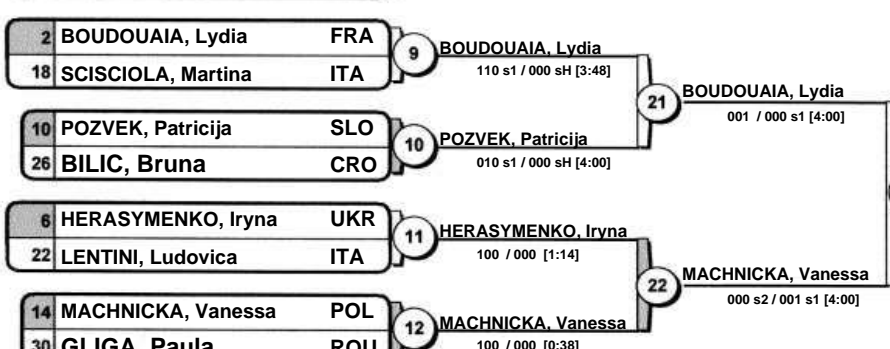

**Pool C - Winner**  
Vainqueur / Sieger

POOL D



**Pool D - Winner**  
Vainqueur / Sieger

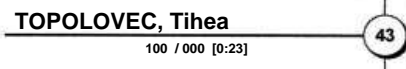

1.

**KAJZER, Kaja**  
000 / 100 [2:11]

Results	
Résultat / Platzierungen	
1.	TOPOLOVEC, Tihea CRO
2.	KAJZER, Kaja SLO
3.	BOUDOUAIA, Lydia FRA
3.	KIRILOVA, Plamena BUL
5.	BROCHOT, Noemie FRA
5.	SCISCIOLA, Martina ITA
7.	TROPAN, Teja SLO
7.	OSTROVSKA, Anelia BUL

Repechage / Trostrunde

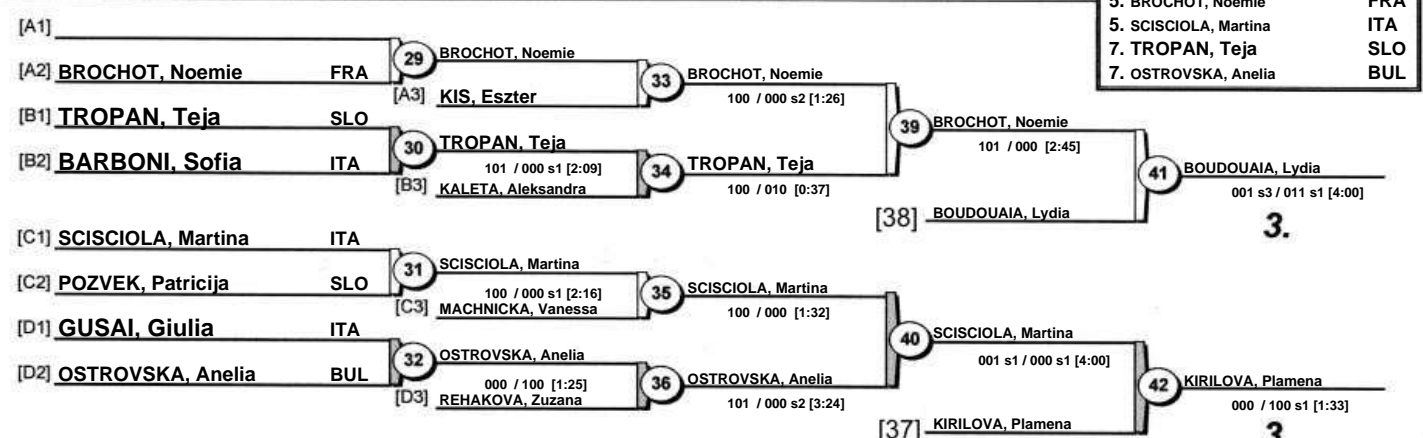



# European Cup Cadets Zagreb 2015

Zagreb (CRO) 14-15 February 2015

## -57 kg

45 Judoka

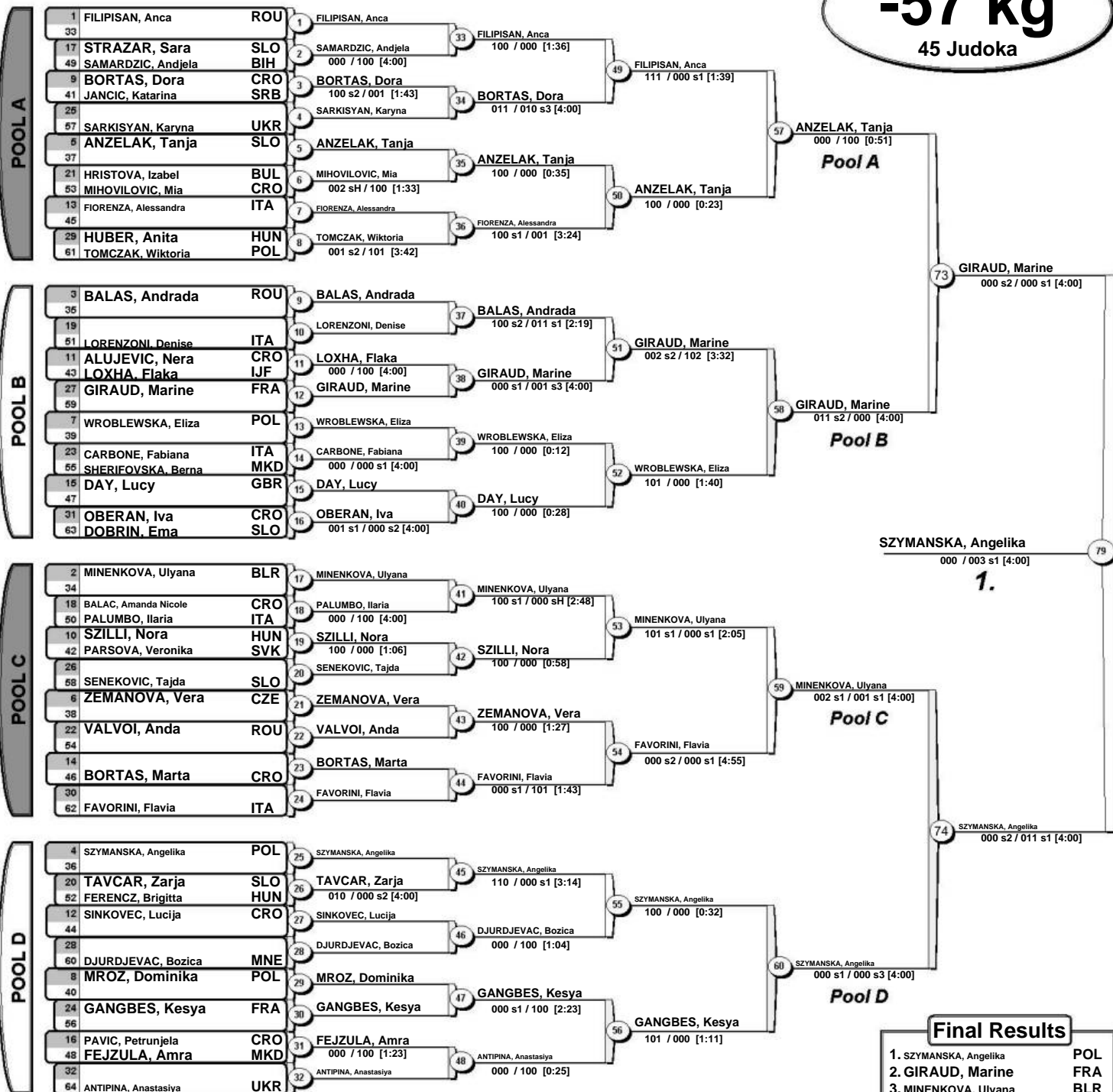

## Repechage

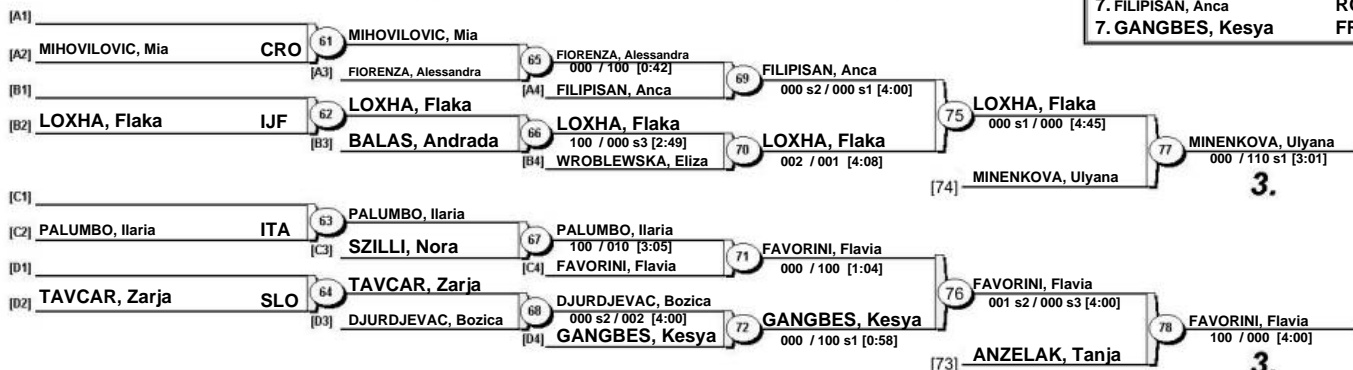



# European Cup Cadets Zagreb 2015

Zagreb (CRO) 14-15 February 2015

## -63 kg

32 Judoka

POOL A

1	MILIC, Mirjana	MNE	1	MILIC, Mirjana	17	MILIC, Mirjana
17	BARSAN, Gabriela	ROU		100 / 000 [0:28]		100 / 000 s1 [2:21]
9	SLATINSEK, Julija	SLO	2	KLIBA, Lara	25	OBRADOVIC, Anja
25	KLIBA, Lara	CRO		000 / 012 s2 [4:00]		000 s1 / 000 [4:38]
5	STUMPP, Tarah	GER	3	STUMPP, Tarah	18	OBRADOVIC, Anja
21	KNEGO, Matea	CRO		101 / 000 s1 [2:03]		000 / 100 [1:55]
13	OBRADOVIC, Anja	SRB	4	OBRADOVIC, Anja	37	OBRADOVIC, Anja
29	TONIOLO, Elisa	ITA		010 s2 / 000 [4:00]		100 / 000 [1:10]

**Pool A - Winner**  
Vainqueur / Sieger

POOL B

3	LISONI, Chiara	ITA	5	LISONI, Chiara	19	LISONI, Chiara
19	KOKORIC, Marta	CRO		100 / 000 s1 [1:03]		011 s2 / 001 [4:00]
11	CSERVENAK, Anna	HUN	6	STOYANOVA, Iliana	26	LISONI, Chiara
27	STOYANOVA, Iliana	BUL		000 s2 / 100 [2:19]		100 s3 / 000 s3 [3:48]
7	D ISANTO, Nicolle	ITA	7	D ISANTO, Nicolle	20	D ISANTO, Nicolle
23	KHRYASHCHEVSKA, Iryna	UKR		000 / 000 s3 [4:00]		000 s2 / 000 s3 [4:00]
15	KLIKOVAC, Bozana	MNE	8	VEREPLA, Leila	43	OBRADOVIC, Jovana
31	VEREPLA, Leila	FRA		000 / 100 [2:10]		000 / 100 [0:36]

**Pool B - Winner**  
Vainqueur / Sieger

POOL C

2	KUKHARUK, Hanna	UKR	9	KUKHARUK, Hanna	21	KUKHARUK, Hanna
18	PISKUNOVA, Darja	LTU		002 s1 / 000 s1 [4:00]		101 / 000 [3:00]
10	VUKOVIC, Helena	CRO	10	SIMEOLI, Nadia	27	SAID ERRHAMANI, Assia
26	SIMEOLI, Nadia	ITA		000 s1 / 101 [3:53]		000 s2 / 101 [4:00]
6	LUNGU, Andra	ROU	11	KUKIC, Ivana	22	SAID ERRHAMANI, Assia
22	KUKIC, Ivana	BIH		000 s2 / 110 s2 [2:08]		000 s2 / 100 [1:02]
14	SIPOS, Babett	HUN	12	SAID ERRHAMANI, Assia	38	OBRADOVIC, Jovana
30	SAID ERRHAMANI, Assia	FRA		000 s1 / 100 [3:08]		000 / 100 [0:47]

**Pool C - Winner**  
Vainqueur / Sieger

POOL D

4	OBRADOVIC, Jovana	SRB	13	OBRADOVIC, Jovana	23	OBRADOVIC, Jovana
20	KULIK, Barbara	POL		100 / 000 [2:00]		100 / 000 [0:50]
12	VOLPE, Ombretta	ITA	14	BOKAREVA, Sofia	28	OBRADOVIC, Jovana
28	BOKAREVA, Sofia	RUS		000 / 100 s1 [1:19]		010 / 000 [4:10]
8	TOMA, Iliana	ROU	15	TOMA, Iliana	24	BABIC, Lucija
24	LUDVIK, Lia	SLO		100 s1 / 000 s1 [1:18]		000 s2 / 100 s1 [3:07]
16	BABIC, Lucija	CRO	16	BABIC, Lucija	42	LISONI, Chiara
32	MILIC, Kristina	MNE		100 / 002 [2:58]		001 / 100 s1 [3:41]

**Pool D - Winner**  
Vainqueur / Sieger

Results	
Résultat / Platzierungen	
1.	OBRADOVIC, Jovana SRB
2.	OBRADOVIC, Anja SRB
3.	SAID ERRHAMANI, Assia FRA
5.	D ISANTO, Nicolle ITA
7.	BABIC, Lucija CRO
	MILIC, Mirjana MNE
	KUKHARUK, Hanna UKR

Repechage / Trostrunde

[A1]	TONIOLO, Elisa	ITA	29	TONIOLO, Elisa	33	MILIC, Mirjana
[A2]	STUMPP, Tarah	GER		010 s1 / 000 [4:00]		000 s1 / 001 [4:00]
[B1]	KOKORIC, Marta	CRO	[A3]	MILIC, Mirjana	39	D ISANTO, Nicolle
[B2]	STOYANOVA, Iliana	BUL	30	STOYANOVA, Iliana		000 s3 / 000 s1 [4:00]
			[B3]	D ISANTO, Nicolle	41	SAID ERRHAMANI, Assia
				000 / 100 [0:59]		000 / 100 s1 [2:19]
				000 / 100 [2:12]	38	SAID ERRHAMANI, Assia
[C1]	SIPOS, Babett	HUN	31	KUKIC, Ivana	40	BABIC, Lucija
[C2]	KUKIC, Ivana	BIH		000 s3 / 000 s2 [4:00]		000 s2 / 000 [4:00]
[D1]	KULIK, Barbara	POL	[C3]	KUKHARUK, Hanna	42	LISONI, Chiara
[D2]	BOKAREVA, Sofia	RUS	32	KULIK, Barbara		001 / 101 [2:10]
			[D3]	BABIC, Lucija	43	LISONI, Chiara
				101 / 000 s2 [1:17]		001 / 100 s1 [3:41]
				000 s1 / 000 [4:00]	37	LISONI, Chiara



# European Cup Cadets Zagreb 2015

Zagreb (CRO) 14-15 February 2015

## -70 kg

25 Judoka

POOL A

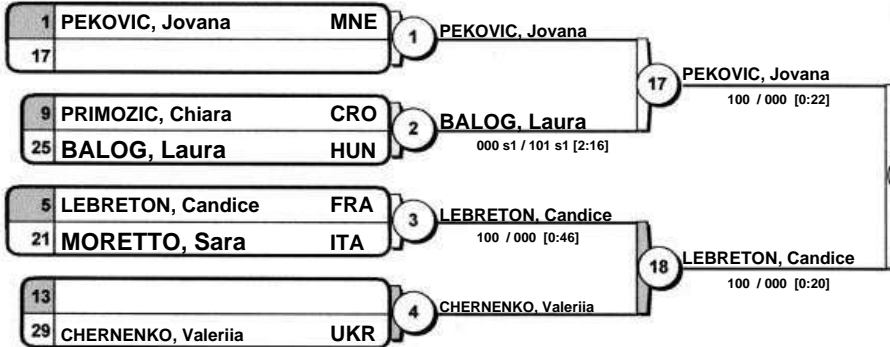

**Pool A - Winner**  
Vainqueur / Sieger

POOL B



**Pool B - Winner**  
Vainqueur / Sieger

POOL C

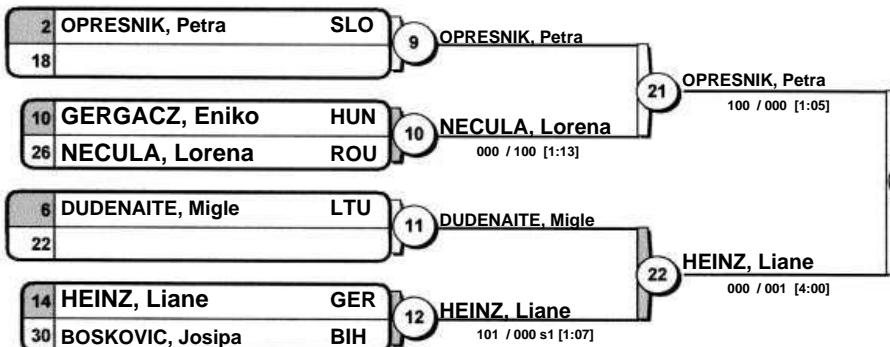

**Pool C - Winner**  
Vainqueur / Sieger

POOL D

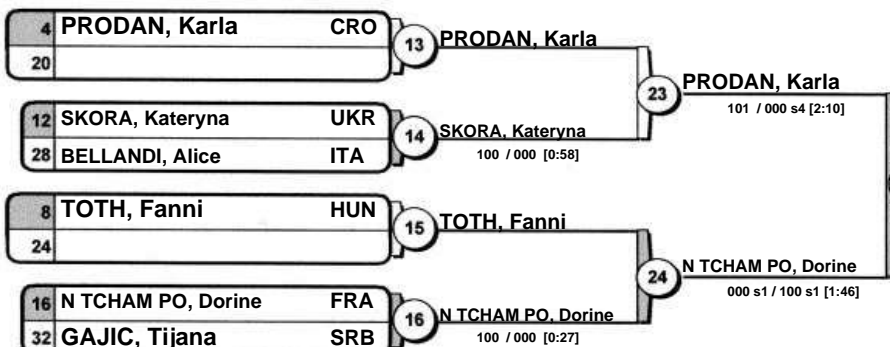

**Pool D - Winner**  
Vainqueur / Sieger

PRODAN, Karla

1.

38 PRODAN, Karla

**Results**  
Résultat / Platzierungen

1. PRODAN, Karla CRO
2. BORISOVA, Boryana BUL
3. OPRESNIK, Petra SLO
3. PEKOVIC, Jovana MNE
5. LEBRETON, Candice FRA
5. HEINZ, Liane GER
7. RADMILOVIC, Djurdjina SRB
7. SKORA, Kateryna UKR

Repechage / Trostrunde

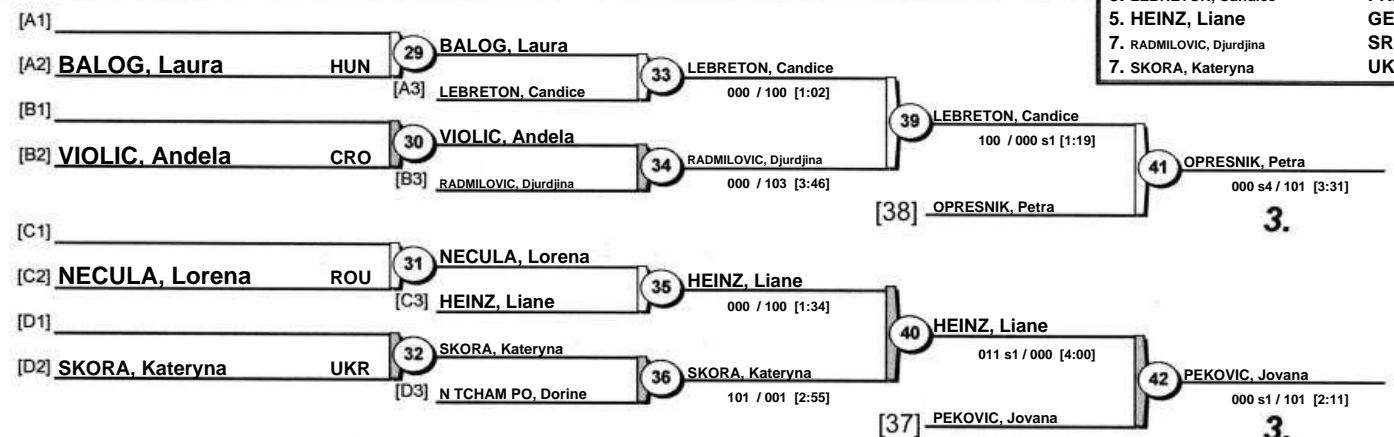

3.

3.



# European Cup Cadets Zagreb 2015

Zagreb (CRO) 14-15 February 2015

## +70 kg

12 Judoka

