

Slovenský zväz JUDO

I. liga dorastencov, 3 . kolo

Sunday 26 May 2013

COMPETITORS PER CLUB

Club: **Bratislava STU**

Name	Yr of Birth	Group	Weight categor	Inscr.nr.
BEZO, Roman	1996	dorastenci	-66 kg	26
BUGAR, David	1996	dorastenci	-81 kg	32
FILO, Norbert	1999	dorastenci	-73 kg	29
GABOR, Stefan	1998	dorastenci	-81 kg	31
KISS, Peter	1996	dorastenci	-60 kg	25
LHOTSKY, Martin	1997	dorastenci	-60 kg	24
MOKOS, Martin	1999	dorastenci	-55 kg	23
NANO, Andrej	1998	dorastenci	-66 kg	28
SIPOS, Jan	1997	dorastenci	-73 kg	30
SLAVIA STU BRATISLAVA		Teams	Team	33
TURAC, Denis	2000	dorastenci	-66 kg	27

Total number of competitors for this club 11

Club: **SK Kolarovo**

Name	Yr of Birth	Group	Weight categor	Inscr.nr.
MOLNAR, David	1997	dorastenci	-55 kg	1
MURANYI, Attila	1998	dorastenci	-81 kg	73
MURANYI, Gabor	1998	dorastenci	+90 kg	2
VAJKAI, Karol	1996	dorastenci	-73 kg	72

Total number of competitors for this club 4

Club: **Martin Judo Club ZTS**

Name	Yr of Birth	Group	Weight categor	Inscr.nr.
BOLIBRUCH, Peter	2000	dorastenci	-55 kg	67
CANIGA, Alex	1997	dorastenci	-60 kg	65
DEVECKA, Pavol	1999	dorastenci	-73 kg	70
GAHER, Richard	1999	dorastenci	-90 kg	61
GAJDOS, Jozef	1996	dorastenci	+90 kg	59
GUNAR, Oliver	1996	dorastenci	-90 kg	62
HLOBEJ, Ivan	1999	dorastenci	+90 kg	50
HODON, Lubomir	1997	dorastenci	-73 kg	63
HOFERICA, Norbert	1999	dorastenci	-66 kg	60
HOFERICA, Peter	1997	dorastenci	-81 kg	51
JAKLOVSKY, Marek	1999	dorastenci	-73 kg	66
JANDA, Patrik	1996	dorastenci	-55 kg	69
JANKOVIC, Ivan	1999	dorastenci	-50 kg	68
JUDO CLUB ZTS MARTIN		Teams	Team	71
KAPRINAJ, Filip	1997	dorastenci	-45 kg	64
KOPIS, Miroslav	1998	dorastenci	-73 kg	47
MAJER, Martin	1997	dorastenci	-60 kg	56
MATIAS, Jan	1998	dorastenci	-66 kg	54
POZNIK, Peter	1998	dorastenci	-45 kg	58
RUTTKAY, Miroslav	2000	dorastenci	-45 kg	49
SCHNIERER, Adam	1998	dorastenci	-55 kg	55
SKULTETY, Matej	1997	dorastenci	-73 kg	52
SOBKULIAK, Rastislav	1998	dorastenci	-90 kg	48
TURJAK, Martin	1999	dorastenci	-66 kg	57

Slovenský zväz JUDO

I. liga dorastencov, 3 . kolo

Sunday 26 May 2013

COMPETITORS PER CLUB

VOLKOV, Peter **1999** **dorastenci** **-55 kg** **53**

Total number of competitors for this club 25

Club: Michalovce SK Zemplin

Name	Yr of Birth	Group	Weight categor	Inscr.nr.
HANKO, Robert	1996	dorastenci	-66 kg	39
KATUSCAK, Ladislav	1996	dorastenci	-81 kg	44
KEREKES, Maros	1999	dorastenci	-55 kg	38
KRIZAK, Marian	1998	dorastenci	+90 kg	41
MICHALOVCE SK ZEMPLIN		Teams	Team	74
MLYNARIC, Daniel	2000	dorastenci	-50 kg	42
NEMCIK, Viktor	1997	dorastenci	-66 kg	46
PAVUK, Filip	1997	dorastenci	-55 kg	45
ROSHKO, Martin	2000	dorastenci	-45 kg	36
RUJAK, Milan	1999	dorastenci	-55 kg	37
SELMANI, Arben	1999	dorastenci	-60 kg	43
VAN DER VALK, Dirk	1999	dorastenci	-60 kg	40

Total number of competitors for this club 12

Club: Pezinok 1. JC

Name	Yr of Birth	Group	Weight categor	Inscr.nr.
KAPUSTA, Jergus	1999	dorastenci	-55 kg	5
KOPECKY, Mario	1997	dorastenci	-66 kg	8
KURA, Lukas	1999	dorastenci	-60 kg	35
KUZEL, Otto	1999	dorastenci	-45 kg	3
NAVARA, Dominik	1998	dorastenci	-66 kg	7
NEMEC, Andrej	1998	dorastenci	-60 kg	6
PEZINOK 1. JC		Teams	Team	13
RANDL, Richard	1996	dorastenci	-73 kg	9
STETIAR, Tomas	1996	dorastenci	-81 kg	11
SZABO, Tomas	2000	dorastenci	-50 kg	34
SZLADICSEK, Alexej	1998	dorastenci	-90 kg	12
UHLIAR, Matej	1996	dorastenci	-81 kg	10
VLADO, Michal	1999	dorastenci	-55 kg	4

Total number of competitors for this club 13

Club: Rimavska Sobota TJ Mladost RELAX

Name	Yr of Birth	Group	Weight categor	Inscr.nr.
ANTAL, Juraj	1998	dorastenci	-55 kg	15
DURMIS, Jan	1996	dorastenci	-60 kg	17
GONDA, Maros	1997	dorastenci	-90 kg	21
HALAJ, Matej	1999	dorastenci	-45 kg	14
KRUTEK, Robert	1998	dorastenci	-60 kg	18
KURAK, Lukas	1998	dorastenci	-81 kg	20
RIMAVSKA SOBOTA TJ MLA		Teams	Team	22
STORK, Michal	1996	dorastenci	-81 kg	19
UTIS, Richard	1998	dorastenci	-55 kg	16

Total number of competitors for this club 9

Slovenský zväz JUDO

I. liga dorastencov, 3 . kolo

Sunday 26 May 2013

COMPETITORS PER CLUB

Slovenský zväz JUDO

I. liga dorastencov, 3 . kolo

Sunday 26 May 2013

COMPETITORS PER WEIGHT CATEGORY

WEIGHT CATEGORY: dorastenci, -45 kg

Name	Inscr.nr	Y.Of.B.	Club:	Country
HALAJ, Matej	14	1999	Rimavska Sobota TJ Mladost RELA	Slovak Republic
KAPRINAJ, Filip	64	1997	Martin Judo Club ZTS	Slovak Republic
KUZEL, Otto	3	1999	Pezinok 1. JC	Slovak Republic
POZNIK, Peter	58	1998	Martin Judo Club ZTS	Slovak Republic
ROSHKO, Martin	36	2000	Michalovce SK Zemplin	Slovak Republic
RUTTKAY, Miroslav	49	2000	Martin Judo Club ZTS	Slovak Republic

Total in this weight category: 6

WEIGHT CATEGORY: dorastenci, -50 kg

Name	Inscr.nr	Y.Of.B.	Club:	Country
JANKOVIC, Ivan	68	1999	Martin Judo Club ZTS	Slovak Republic
MLYNARIC, Daniel	42	2000	Michalovce SK Zemplin	Slovak Republic
SZABO, Tomas	34	2000	Pezinok 1. JC	Slovak Republic

Total in this weight category: 3

WEIGHT CATEGORY: dorastenci, -55 kg

Name	Inscr.nr	Y.Of.B.	Club:	Country
ANTAL, Juraj	15	1998	Rimavska Sobota TJ Mladost RELA	Slovak Republic
BOLIBRUCH, Peter	67	2000	Martin Judo Club ZTS	Slovak Republic
JANDA, Patrik	69	1996	Martin Judo Club ZTS	Slovak Republic
KAPUSTA, Jergus	5	1999	Pezinok 1. JC	Slovak Republic
KEREKES, Maros	38	1999	Michalovce SK Zemplin	Slovak Republic
MOKOS, Martin	23	1999	Bratislava STU	Slovak Republic
MOLNAR, David	1	1997	SKKolarovo	Slovak Republic
PAVUK, Filip	45	1997	Michalovce SK Zemplin	Slovak Republic
RUJAK, Milan	37	1999	Michalovce SK Zemplin	Slovak Republic
SCHNIERER, Adam	55	1998	Martin Judo Club ZTS	Slovak Republic
UTIS, Richard	16	1998	Rimavska Sobota TJ Mladost RELA	Slovak Republic
VLADO, Michal	4	1999	Pezinok 1. JC	Slovak Republic
VOLKOV, Peter	53	1999	Martin Judo Club ZTS	Slovak Republic

Total in this weight category: 13

WEIGHT CATEGORY: dorastenci, -60 kg

Name	Inscr.nr	Y.Of.B.	Club:	Country
CANIGA, Alex	65	1997	Martin Judo Club ZTS	Slovak Republic
DURMIS, Jan	17	1996	Rimavska Sobota TJ Mladost RELA	Slovak Republic
KISS, Peter	25	1996	Bratislava STU	Slovak Republic
KRUTEK, Robert	18	1998	Rimavska Sobota TJ Mladost RELA	Slovak Republic
KURA, Lukas	35	1999	Pezinok 1. JC	Slovak Republic
LHOTSKY, Martin	24	1997	Bratislava STU	Slovak Republic
MAJER, Martin	56	1997	Martin Judo Club ZTS	Slovak Republic
NEMEC, Andrej	6	1998	Pezinok 1. JC	Slovak Republic
SELMANI, Arben	43	1999	Michalovce SK Zemplin	Slovak Republic
VALK, Dirk van der	40	1999	Michalovce SK Zemplin	Slovak Republic

Total in this weight category: 10

WEIGHT CATEGORY: dorastenci, -66 kg

Name	Inscr.nr	Y.Of.B.	Club:	Country
BEZO, Roman	26	1996	Bratislava STU	Slovak Republic
HANKO, Robert	39	1996	Michalovce SK Zemplin	Slovak Republic

Slovenský zväz JUDO

I. liga dorastencov, 3 . kolo

Sunday 26 May 2013

COMPETITORS PER WEIGHT CATEGORY

HOFERICA, Norbert	60	1999	Martin Judo Club ZTS	Slovak Republic
KOPECKY, Mario	8	1997	Pezinok 1. JC	Slovak Republic
MATIAS, Jan	54	1998	Martin Judo Club ZTS	Slovak Republic
NANO, Andrej	28	1998	Bratislava STU	Slovak Republic
NAVARA, Dominik	7	1998	Pezinok 1. JC	Slovak Republic
NEMCIK, Viktor	46	1997	Michalovce SK Zemplin	Slovak Republic
TURAC, Denis	27	2000	Bratislava STU	Slovak Republic
TURJAK, Martin	57	1999	Martin Judo Club ZTS	Slovak Republic

Total in this weight category: 10

WEIGHT CATEGORY: dorastenci, -73 kg

Name	Inscr.nr	Y.Of.B.	Club:	Country
DEVECKA, Pavol	70	1999	Martin Judo Club ZTS	Slovak Republic
FILO, Norbert	29	1999	Bratislava STU	Slovak Republic
HODON, Lubomir	63	1997	Martin Judo Club ZTS	Slovak Republic
JAKLOVSKY, Marek	66	1999	Martin Judo Club ZTS	Slovak Republic
KOPIS, Miroslav	47	1998	Martin Judo Club ZTS	Slovak Republic
RANDL, Richard	9	1996	Pezinok 1. JC	Slovak Republic
SIPOS, Jan	30	1997	Bratislava STU	Slovak Republic
SKULTETY, Matej	52	1997	Martin Judo Club ZTS	Slovak Republic
VAJKAI, Karol	72	1996	SKKolarovo	Slovak Republic

Total in this weight category: 9

WEIGHT CATEGORY: dorastenci, -81 kg

Name	Inscr.nr	Y.Of.B.	Club:	Country
BUGAR, David	32	1996	Bratislava STU	Slovak Republic
GABOR, Stefan	31	1998	Bratislava STU	Slovak Republic
HOFERICA, Peter	51	1997	Martin Judo Club ZTS	Slovak Republic
KATUSCAK, Ladislav	44	1996	Michalovce SK Zemplin	Slovak Republic
KURAK, Lukas	20	1998	Rimavska Sobota TJ Mladost RELA	Slovak Republic
MURANYI, Attila	73	1998	SKKolarovo	Slovak Republic
STETIAR, Tomas	11	1996	Pezinok 1. JC	Slovak Republic
STORK, Michal	19	1996	Rimavska Sobota TJ Mladost RELA	Slovak Republic
UHLIAR, Matej	10	1996	Pezinok 1. JC	Slovak Republic

Total in this weight category: 9

WEIGHT CATEGORY: dorastenci, -90 kg

Name	Inscr.nr	Y.Of.B.	Club:	Country
GAHER, Richard	61	1999	Martin Judo Club ZTS	Slovak Republic
GONDA, Maros	21	1997	Rimavska Sobota TJ Mladost RELA	Slovak Republic
GUNAR, Oliver	62	1996	Martin Judo Club ZTS	Slovak Republic
SOBKULIAK, Rastislav	48	1998	Martin Judo Club ZTS	Slovak Republic
SZLADICSEK, Alexej	12	1998	Pezinok 1. JC	Slovak Republic

Total in this weight category: 5

WEIGHT CATEGORY: dorastenci, +90 kg

Name	Inscr.nr	Y.Of.B.	Club:	Country
GAJDOS, Jozef	59	1996	Martin Judo Club ZTS	Slovak Republic
HLOBEJ, Ivan	50	1999	Martin Judo Club ZTS	Slovak Republic
KRIZAK, Marian	41	1998	Michalovce SK Zemplin	Slovak Republic
MURANYI, Gabor	2	1998	SKKolarovo	Slovak Republic

Total in this weight category: 4

Slovenský zväz JUDO

I. liga dorastencov, 3 . kolo

Sunday 26 May 2013

COMPETITORS PER WEIGHT CATEGORY

WEIGHT CATEGORY: Teams, Nadstavbova cast

Name	Inscr.nr	Y.Of.B. Club:	Country
JUDO CLUB ZTS MARTIN,	71	Martin Judo Club ZTS	Slovak Republic
MICHALOVCE SK ZEMPLIN,	74	Michalovce SK Zemplin	Slovak Republic
PEZINOK 1. JC,	13	Pezinok 1. JC	Slovak Republic
RIMAVSKA SOBOTA TJ MLADOST	22	Rimavska Sobota TJ Mladost RELA	Slovak Republic
SLAVIA STU BRATISLAVA,	33	Bratislava STU	Slovak Republic

Total in this weight category: 5

Slovenský zväz JUDO

I. liga dorastencov, 3 . kolo - MEDAL WINNERS

Teams

- bova cast
- 1 JUDO CLUB ZTS MARTIN
Martin Judo Club ZTS
 - 2 PEZINOK 1. JC
Pezinok 1. JC
 - 3 SLAVIA STU BRATISLAVA
Bratislava STU

Slovenský zväz JUDO

I. liga dorastencov, 3 . kolo - MEDAL WINNERS

dorastenci

-45 kg	1 RUTTKAY, Miroslav Martin Judo Club ZTS	-50 kg	1 JANKOVIC, Ivan Martin Judo Club ZTS
	2 ROSHKO, Martin Michalovce SK Zemplin		2 SZABO, Tomas Pezinok 1. JC
	3 POZNIK, Peter Martin Judo Club ZTS		3 MLYNARIC, Daniel Michalovce SK Zemplin
	3 KAPRINAJ, Filip Martin Judo Club ZTS		
	5 KUZEL, Otto Pezinok 1. JC		
	5 HALAJ, Matej Rimavska Sobota TJ Mladost RELAX		
-55 kg	1 MOKOS, Martin Bratislava STU	-60 kg	1 MAJER, Martin Martin Judo Club ZTS
	2 KAPUSTA, Jergus Pezinok 1. JC		2 LHOTSKY, Martin Bratislava STU
	3 ANTAL, Juraj Rimavska Sobota TJ Mladost RELAX		3 DURMIS, Jan Rimavska Sobota TJ Mladost RELAX
	3 UTIS, Richard Rimavska Sobota TJ Mladost RELAX		3 NEMEC, Andrej Pezinok 1. JC
	5 VOLKOV, Peter Martin Judo Club ZTS		5 KRUTEK, Robert Rimavska Sobota TJ Mladost RELAX
	5 SCHNIERER, Adam Martin Judo Club ZTS		5 VAN DER VALK, Dirk Michalovce SK Zemplin
-66 kg	1 BEZO, Roman Bratislava STU	-73 kg	1 RANDL, Richard Pezinok 1. JC
	2 KOPECKY, Mario Pezinok 1. JC		2 SIPOS, Jan Bratislava STU
	3 TURAC, Denis Bratislava STU		3 KOPIS, Miroslav Martin Judo Club ZTS
	3 MATIAS, Jan Martin Judo Club ZTS		3 VAJKAI, Karol Kolarovo
	5 TURJAK, Martin Martin Judo Club ZTS		5 DEVECKA, Pavol Martin Judo Club ZTS
	5 HOFERICA, Norbert Martin Judo Club ZTS		5 SKULTETY, Matej Martin Judo Club ZTS
-81 kg	1 HOFERICA, Peter Martin Judo Club ZTS	-90 kg	1 GUNAR, Oliver Martin Judo Club ZTS
	2 STETIAR, Tomas Pezinok 1. JC		2 GONDA, Maros Rimavska Sobota TJ Mladost RELAX
	3 STORK, Michal Rimavska Sobota TJ Mladost RELAX		3 SZLADICSEK, Alexej Pezinok 1. JC
	3 BUGAR, David Bratislava STU		4 SOBKULIAK, Rastislav Martin Judo Club ZTS
	5 KURAK, Lukas Rimavska Sobota TJ Mladost RELAX		5 GAHER, Richard Martin Judo Club ZTS
	5 GABOR, Stefan Bratislava STU		
+90 kg	1 MURANYI, Gabor Kolarovo		
	2 GAJDOS, Jozef Martin Judo Club ZTS		
	3 KRIZAK, Marian Michalovce SK Zemplin		
	4 HLOBEJ, Ivan Martin Judo Club ZTS		

Slovenský zväz JUDO

I. liga dorastencov, 3 . kolo

MEDALS PER CLUB PER GROUP

dorastenci	Gold	Silver	Bronze	4	5	7
1 Martin Judo Club ZTS	5	1	4	2	7	3
2 Bratislava STU	2	2	2		1	1
3 Pezinok 1. JC	1	4	2		1	1
4 Kolarovo, SK	1		1			1
5 Rimavska Sobota TJ Mladost RELAX		1	4		3	
6 Michalovce SK Zemplin		1	2		1	4

Slovenský zväz JUDO

I. liga dorastencov, 3 . kolo

MEDALS PER CLUB PER GROUP

Nadstavbova cast	Gold	Silver	Bronze	4	5	7
1 Martin Judo Club ZTS	1					
2 Pezinok 1. JC		1				
3 Bratislava STU			1			

Slovenský zväz JUDO

I. liga dorastencov, 3 . kolo
Weight category: dorastenci -45 kg



1 ^e	RUTTKAY, Miroslav	JcMT
2 ^e	ROSHKO, Martin	SKMI
3 ^e	POZNIK, Peter	JcMT
3 ^e	KAPRINAJ, Filip	JcMT

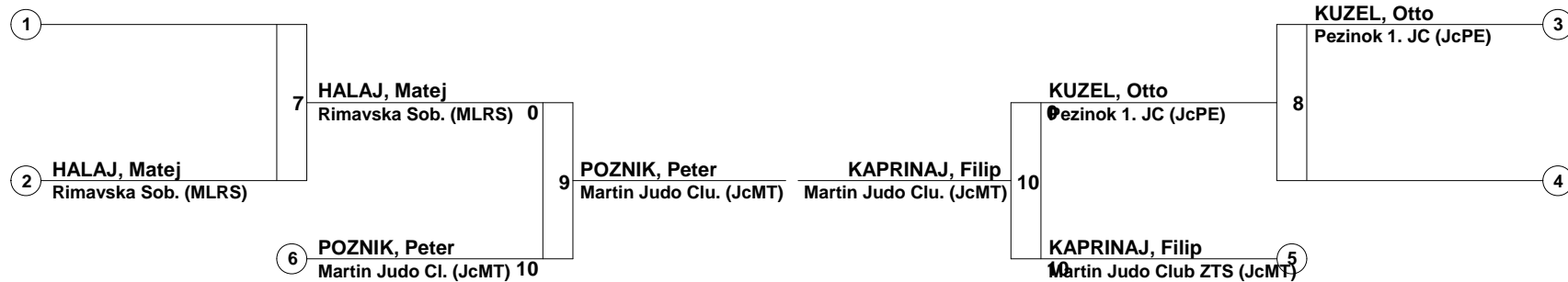

Slovenský zväz JUDO

I. liga dorastencov, 3 . kolo *Weight category: dorastenci -50 kg*

	1	2	3	Games won	Pl.
				Gameresults	
MLYNARIC, Daniel [Michalovce SK Zemplin (SKMI)]	2	0		2	3
	10	0		10	
JANKOVIC, Ivan [Martin Judo Club ZTS (JcMT)]	0		2	2	1
	0		10	10	
SZABO, Tomas [Pezinok 1. JC (JcPE)]		2	0	2	2
		10	0	10	

Slovenský zväz JUDO

I. liga dorastencov, 3 . kolo Weight category: dorastenci -55 kg

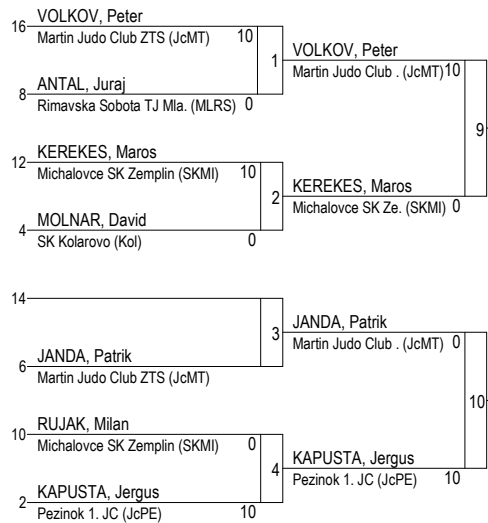

1^e	MOKOS, Martin	SUBa
2^e	KAPUSTA, Jergus	JcPE
3^e	ANTAL, Juraj	MLRS
3^e	UTIS, Richard	MLRS

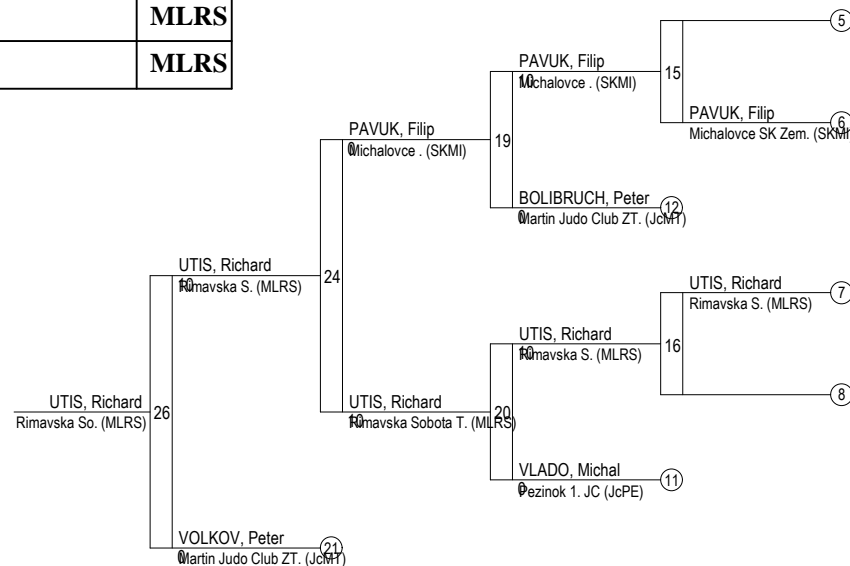
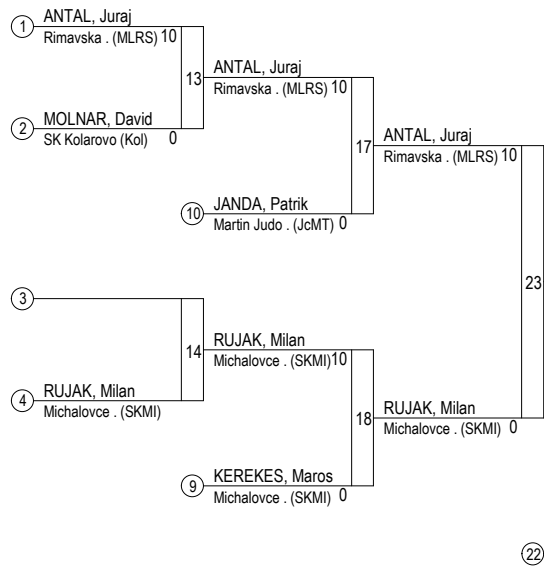
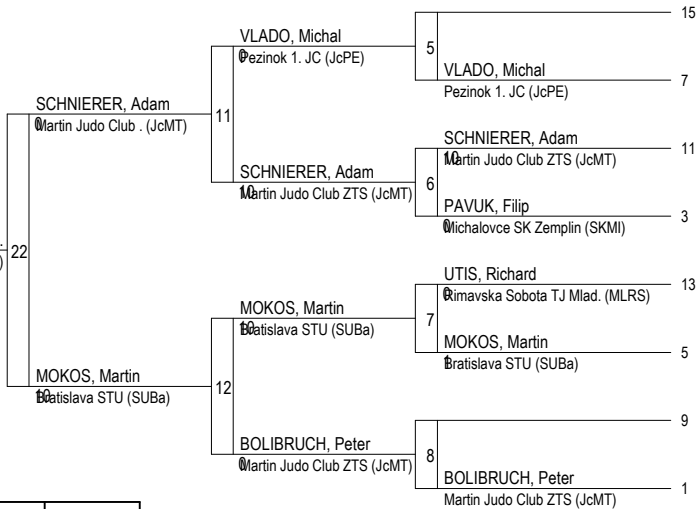

Slovenský zväz JUDO

I. liga dorastencov, 3 . kolo Weight category: dorastenci -60 kg

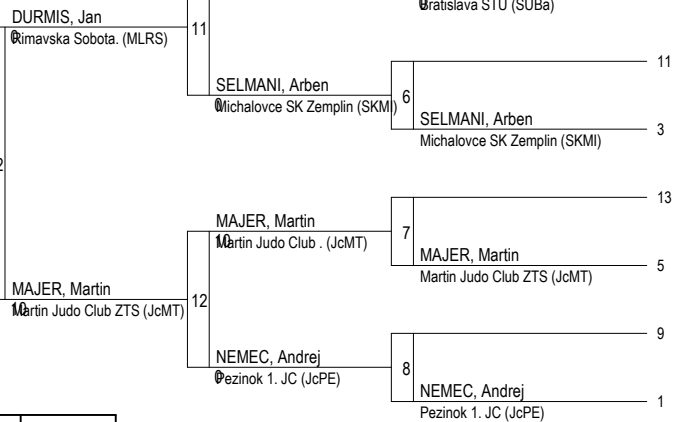
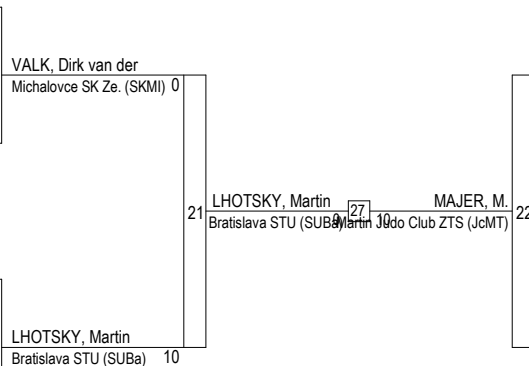
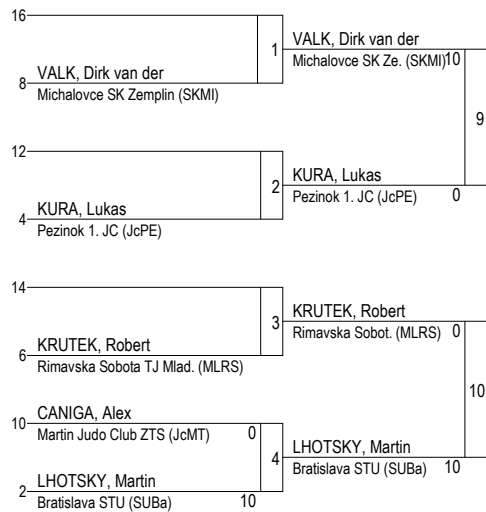

1^e	MAJER, Martin	JcMT
2^e	LHOTSKY, Martin	SUBa
3^e	DURMIS, Jan	MLRS
3^e	NEMEC, Andrej	JcPE

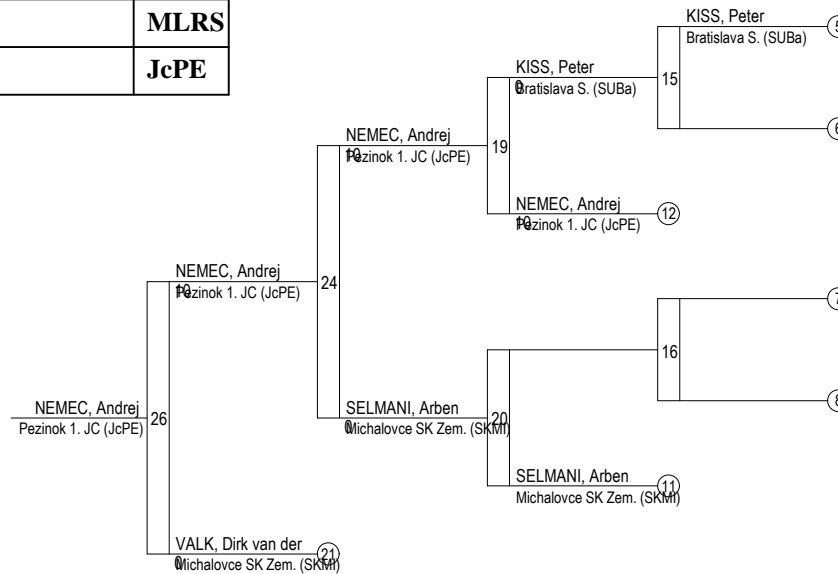
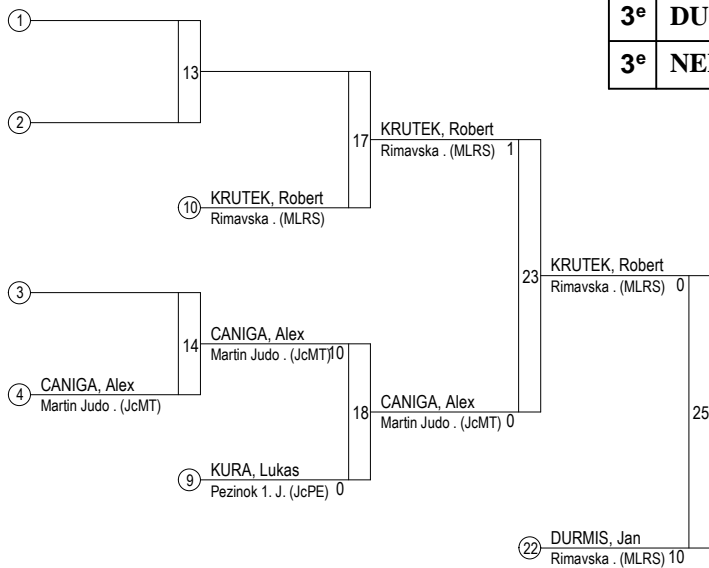

Slovenský zväz JUDO

I. liga dorastencov, 3 . kolo Weight category: dorastenci -66 kg

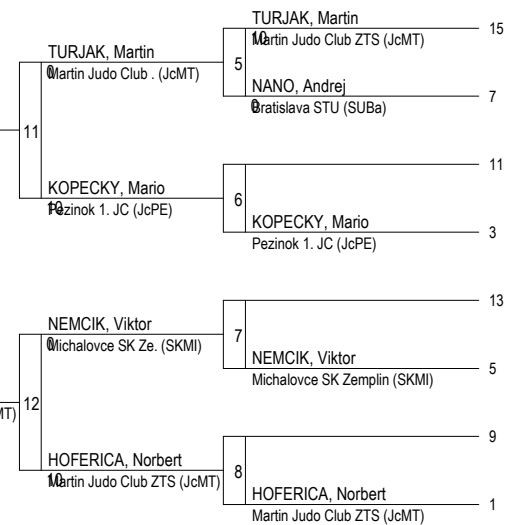
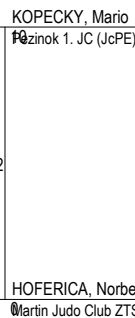
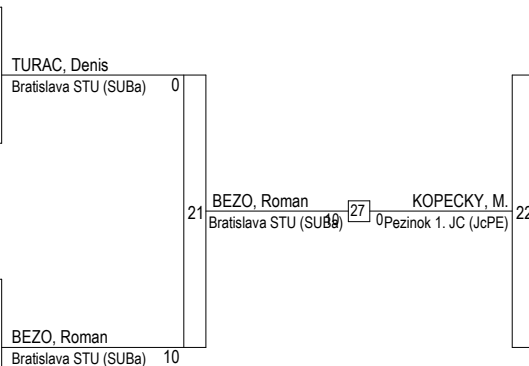
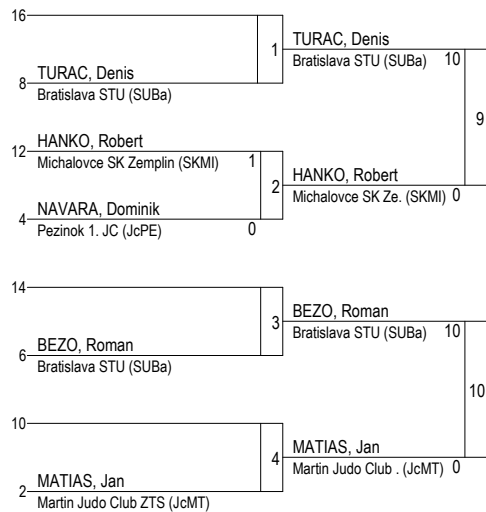

1 ^e	BEZO, Roman	SUBa
2 ^e	KOPECKY, Mario	JcPE
3 ^e	MATIAS, Jan	JcMT
3 ^e	TURAC, Denis	SUBa

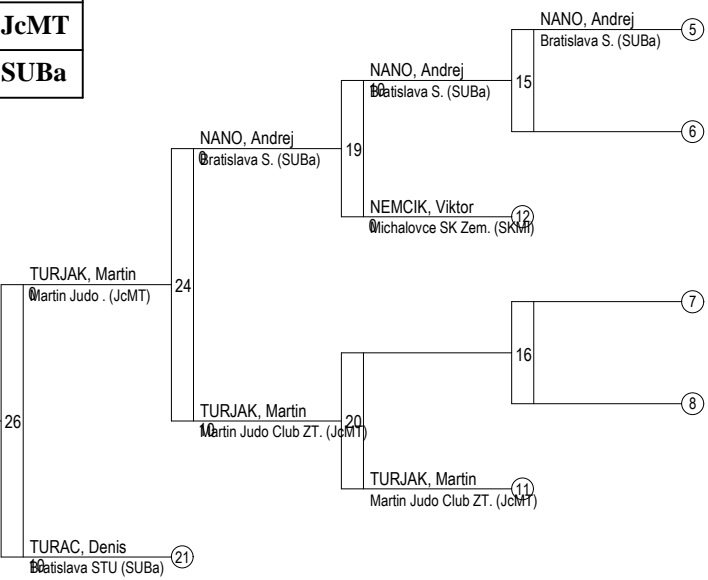
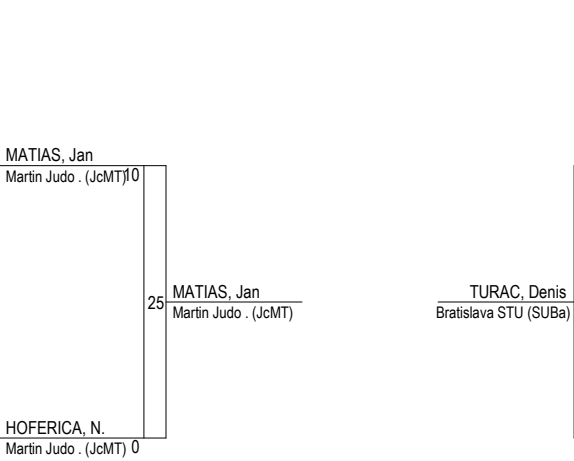
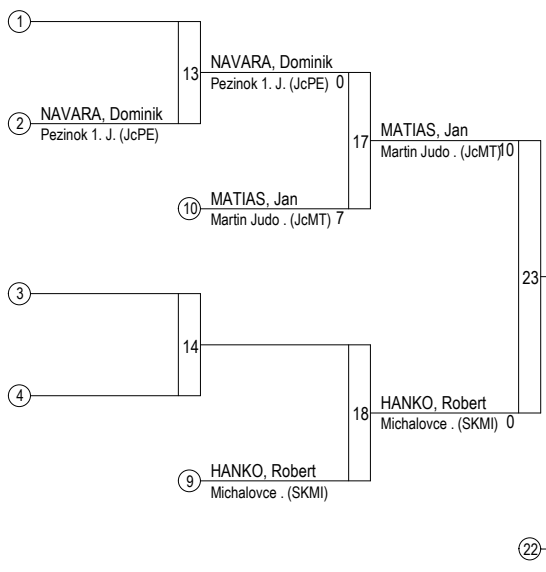

Slovenský zväz JUDO

I. liga dorastencov, 3 . kolo Weight category: dorastenci -73 kg

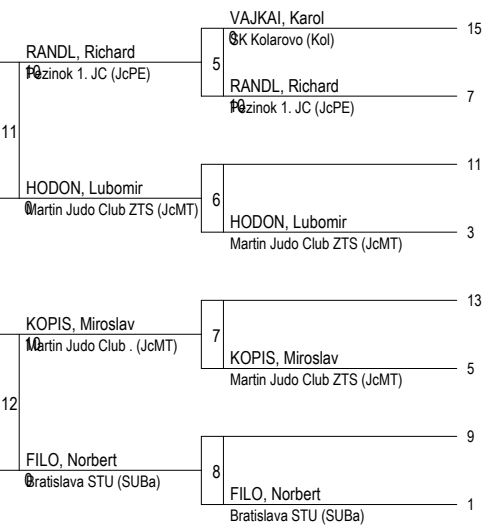
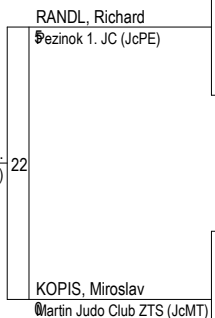
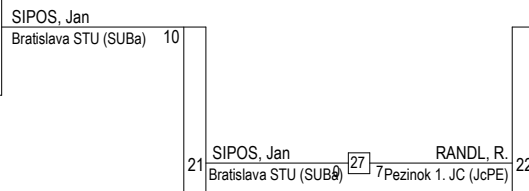
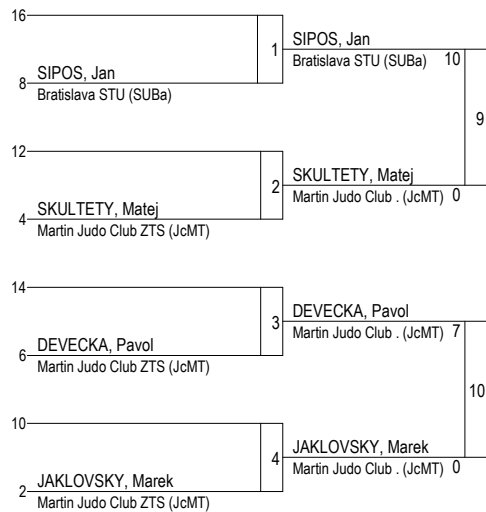

1^e	RANDL, Richard	JcPE
2^e	SIPOS, Jan	SUBa
3^e	KOPIS, Miroslav	JcMT
3^e	VAJKAI, Karol	Kol

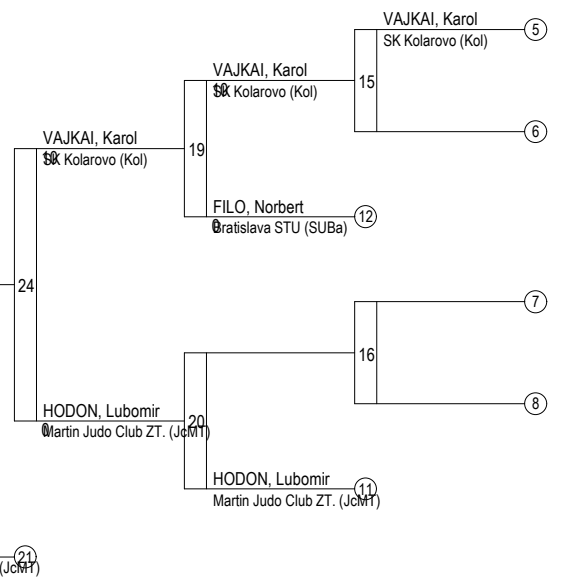
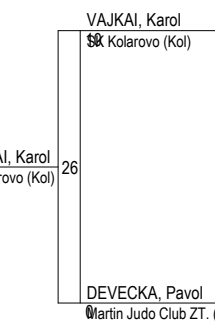
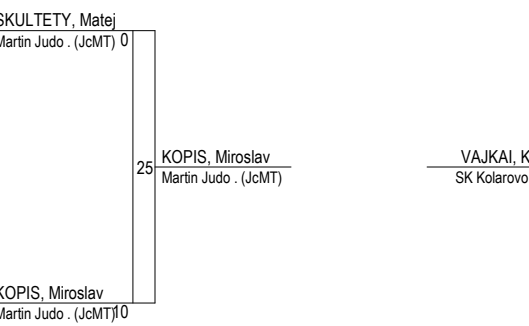
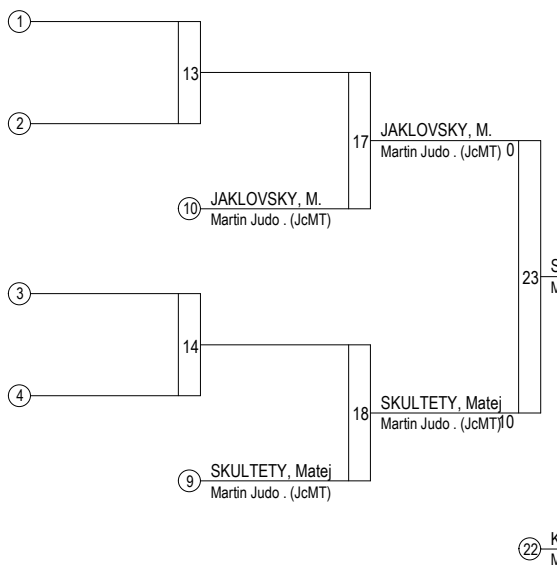

Slovenský zväz JUDO

I. liga dorastencov, 3 . kolo Weight category: dorastenci -81 kg

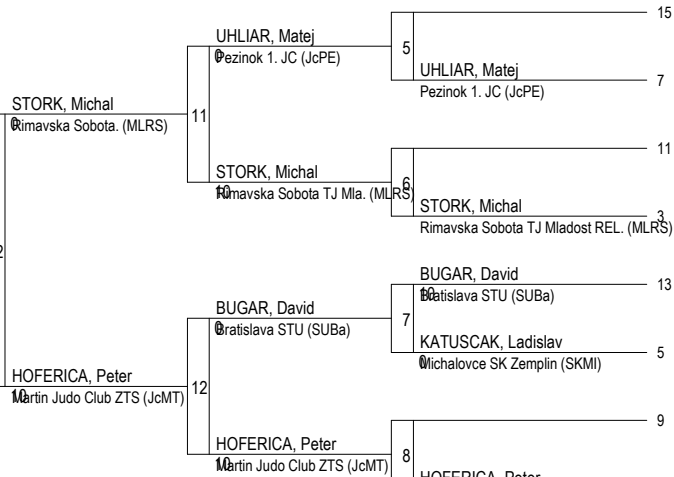
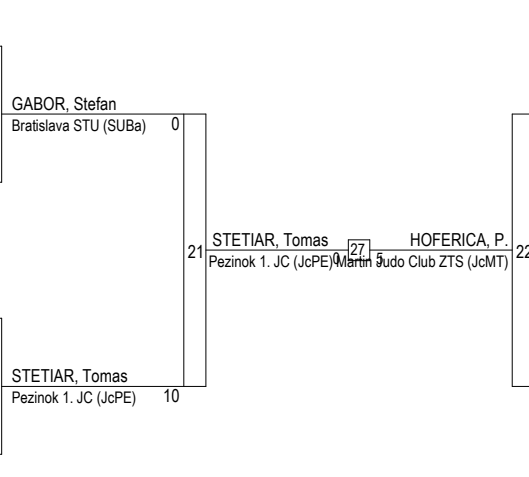
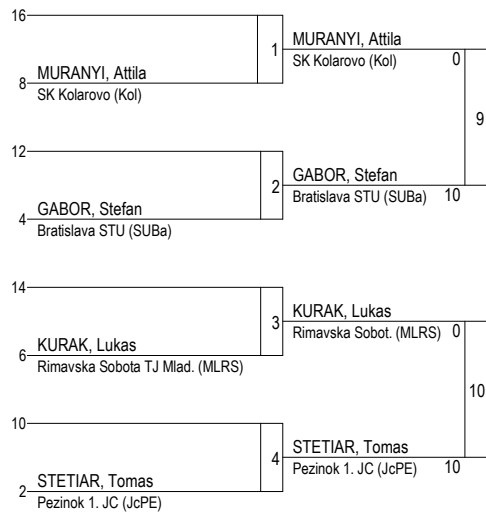

1^e	HOFERICA, Peter	JcMT
2^e	STETIAR, Tomas	JcPE
3^e	STORK, Michal	MLRS
3^e	BUGAR, David	SUBa

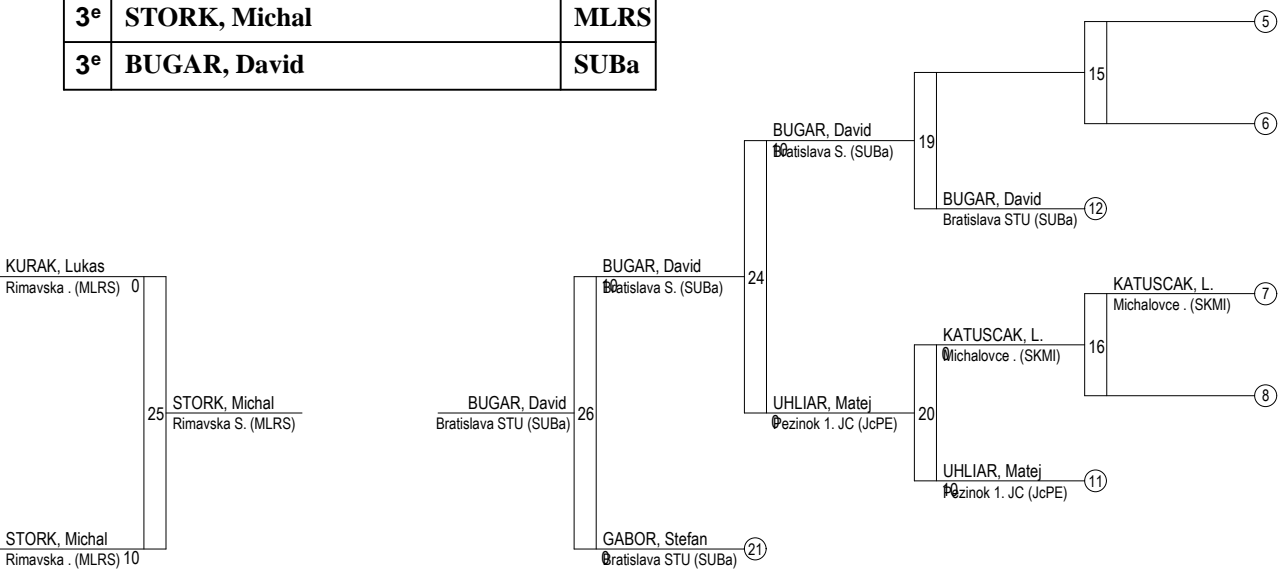
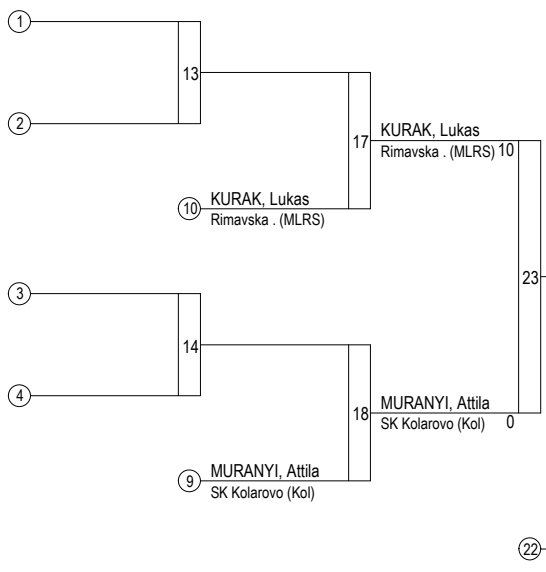

Slovenský zväz JUDO

I. liga dorastencov, 3 . kolo

Weight category: dorastenci -90 kg

	1	2	3	4	5	6	7	8	9	10	Games won	Pl.
											Gameresults	
GAHER, Richard [Martin Judo Club ZTS (JcMT)]	0		0			0			0			5
	0		0			0			0			
GUNAR, Oliver [Martin Judo Club ZTS (JcMT)]	2			2			2			2	8	1
	10			10			10			10	40	
SOBKULIAK, Rastislav [Martin Judo Club ZTS (JcMT)]		0		0		2		0			2	4
		0		0		10		0			10	
GONDA, Maros [Rimavska Sobota TJ Mladost RELA]		2			2		0		2		6	2
		10			10		0		10		30	
SZLADICSEK, Alexej [Pezinok 1. JC (JcPE)]			2		0			2		0	4	3
			10		0			7		0	17	

Slovenský zväz JUDO

I. liga dorastencov, 3 . kolo

Weight category: dorastenci +90 kg

	1	2	3	4	5	6	Games won	Pl.
							Gameresults	
GAJDOS, Jozef [Martin Judo Club ZTS (JcMT)]	2		0		2		4	2
	10		0		10		20	
HLOBEJ, Ivan [Martin Judo Club ZTS (JcMT)]	0			0		0		4
	0			0		0		
KRIZAK, Marian [Michalovce SK Zemplin (SKMI)]		0		2	0		2	3
		0		10	0		10	
MURANYI, Gabor [SK Kolarovo (Kol)]		2	2			2	6	1
		10	10			10	30	

		RESULTS	
1	JUDO CLUB ZTS MARTIN Martin Judo Club ZTS (JcMT) 6/52	1	JUDO CLUB ZTS MARTIN Martin Judo Club ZTS (JcMT) 3/30
3	RIMAVSKA SOBOTA TJ MLADOST R. 1/10 Rimavska Sobota TJ Mladost RELAX (MLRS)	4	JUDO CLUB ZTS MARTIN Martin Judo Club ZTS (JcMT)
2	PEZINOK 1. JC 4/35 Pezinok 1. JC (JcPE)	2	PEZINOK 1. JC 1/10 Pezinok 1. JC (JcPE)
4	SLAVIA STU BRATISLAVA 3/30 Bratislava STU (SUBa)	3	SLAVIA STU BRATISLAVA Bratislava STU (SUBa)
			RIMAVSKA SOBOTA TJ MLADO. 0/00 Rimavska Sobota TJ Mladost RE. (MLRS)
			SLAVIA STU BRATISLAVA 6/60 Bratislava STU (SUBa)



Slovenský zväz JUDO

I. liga dorastencov, 3 . kolo

27th May 2013

druzs, fight 1

Team 1: Judo Club ZTS Martin

Team 2: Rimavska Sobota TJ Mladost RELAX

Weight	Name	Wins	Name	Wins		
		Points		Points		
-50 kg	RUTTKAY, Miroslav	1		0		
		10		0		
-55 kg	VOLKOV, Peter	0	UTIS, Richard	1		
		0		10		
-60 kg	MAJER, Martin	1	DURMIS, Jan	0		
		7		0		
-66 kg	MATIAS, Jan	1	KRUTEK, Robert	0		
		5		0		
-73 kg	KOPIS, Miroslav	1		0		
		10		0		
-81 kg	HOFERICA, Peter	1	STORK, Michal	0		
		10		0		
-90 kg	SOBKULIAK, Rastislav	1	GONDA, Maros	0		
		10		0		
Total:		Fights 6	Points 52	Total:	Fights 1	Points 10

Winner: Judo Club ZTS Martin

Signature

Captain team 1	Central Referee	Captain team 2
_____	_____	_____



Slovenský zväz JUDO

I. liga dorastencov, 3 . kolo

27th May 2013

druzs, fight 3

Team 1: Rimavska Sobota TJ Mladost RELAX

Team 2: Slavia STU Bratislava

Weight	Name	Wins	Name	Wins			
		Points		Points			
-50 kg		0		0			
		0					
-55 kg		0	MOKOS, Martin	1			
		0		10			
-60 kg		0	LHOTSKY, Martin	1			
		0		10			
-66 kg		0	BEZO, Roman	1			
		0		10			
-73 kg		0	FILO, Norbert	1			
		0		10			
-81 kg		0	SIPOS, Jan	1			
		0		10			
-90 kg		0	BUGAR, David	1			
		0		10			
Total:		Fights 0	Points 0	Total:		Fights 6	Points 60

Winner: Slavia STU Bratislava

Signature

Captain team 1	Central Referee	Captain team 2
_____	_____	_____



Slovenský zväz JUDO

I. liga dorastencov, 3 . kolo

27th May 2013

druzs, fight 2

Team 1: Pezinok 1. JC

Team 2: Slavia STU Bratislava

Weight	Name	Wins	Name	Wins		
		Points		Points		
-50 kg	SZABO, Tomas	1		0		
		10		0		
-55 kg	KAPUSTA, Jergus	0	MOKOS, Martin	1		
		0		10		
-60 kg	NEMEC, Andrej	0	LHOTSKY, Martin	1		
		0		10		
-66 kg	KOPECKY, Mario	0	BEZO, Roman	1		
		0		10		
-73 kg	RANDL, Richard	1	SIPOS, Jan	0		
		5		0		
-81 kg	STETIAR, Tomas	1	BUGAR, David	0		
		10		0		
-90 kg	SZLADICSEK, Alexej	1	GABOR, Stefan	0		
		10		0		
Total:		Fights 4	Points 35	Total:	Fights 3	Points 30

Winner: Pezinok 1. JC

Signature

Captain team 1	Central Referee	Captain team 2
_____	_____	_____



Slovenský zväz JUDO

I. liga dorastencov, 3 . kolo

27th May 2013

druzs, fight 4

Team 1: Judo Club ZTS Martin

Team 2: Pezinok 1. JC

Weight	Name	Wins	Name	Wins			
		Points		Points			
-50 kg	RUTTKAY, Miroslav	1	SZABO, Tomas	0			
		10		0			
-55 kg	SCHNIERER, Adam	0	KAPUSTA, Jergus	0			
		0					
-60 kg	MAJER, Martin	1	NEMEC, Andrej	0			
		10		0			
-66 kg	TURJAK, Martin	0	KOPECKY, Mario	1			
		0		10			
-73 kg	KOPIS, Miroslav	0	RANDL, Richard	0			
		0					
-81 kg	HOFERICA, Peter	0	STETIAR, Tomas	0			
		0					
-90 kg	SOBKULIAK, Rastislav	1	SZLADICSEK, Alexej	0			
		10		0			
Total:		Fights 3	Points 30	Total:		Fights 1	Points 10

Winner: Judo Club ZTS Martin

Signature

Captain team 1

Central Referee

Captain team 2
